

Australian Vehicle Standards Rules 1999

August 2007

These Rules were approved by the Australian Transport Council on 29 January 1999.

This version of the Rules includes all amendments approved by the Australian Transport Council up to 23 August 2006 (see last page for the amending regulations).

Please note that this consolidated version of the Rules has been prepared by the National Transport Commission for the convenience of readers.

The National Transport Commission has taken care to ensure the accuracy of this version; however, readers are advised that the official versions of the Rules and all amendments to the Rules are located in the Federal Register of Legislative Instruments (Commonwealth): <http://www.frli.gov.au>

Contents

	Page
Part 1 Introductory.....	1
Division 1 General 1	
1 Name of regulations	1
2 Object of Vehicle Standards.....	1
Division 2 Some features of the Vehicle Standards	2
3 Definitions — the dictionary etc.....	2
4 Diagrams	2
5 Notes	2
6 Examples	3
Part 2 Application of the Vehicle Standards.....	4
7 Application to vehicles and combinations on roads and road-related areas 4	
8 What is a road	4
9 What is a road-related area.....	4
10 Vehicles to which the Vehicle Standards do not apply	4
11 Non-application of Vehicle Standards — exemption under other laws.....	5
12 Non-application of Vehicle Standards — inconsistent ADR requirements	5
13 Non-application of Vehicle Standards — Motor Vehicle Standards Act approvals	6
Part 3 Australian Design Rules.....	7
Division 1 Interpretation	8
14 What is an ADR.....	8
15 What is a national standard.....	8
16 References to national standards	8
17 What is a second edition ADR	8
18 What is a third edition ADR	8

	Page
Division 2 Compliance with ADRs	9
19 Compliance with second edition ADRs	9
20 Compliance with third edition ADRs	10
21 Exception to compliance with ADRs — vehicles that are not road vehicles	10
22 Exception to compliance with ADRs — Motor Vehicle Standards Act	11
23 Partial exception to compliance with ADRs — personally imported vehicles	12
Part 4 Adopted standards	13
24 What is an adopted standard	13
25 Reference to adopted standards	13
26 Exception to compliance with adopted standards	13
Part 5 General safety requirements	14
Division 1 All vehicles	14
27 Steering	14
28 Turning ability	15
29 Ability to travel backwards and forwards	15
30 Protrusions	15
31 Driver's view and vehicle controls	15
32 Seating	16
33 Mudguards and spray suppression	16
34 Horns, alarms etc	17
35 Rear vision mirrors	18
36 Rear vision mirrors — surfaces	19
37 Additional rear vision mirrors	19
38 Automatic transmission	20
39 Diesel engines	20
40 Bonnet securing devices	20
41 Electrical wiring, components, connections and installations	20
42 Television receivers and visual display units	21
42A Requirement for windscreen to be fitted	22
43 Windscreens and windows	22
44 Window tinting	23
45 Windscreen wipers and washers	24
46 Wheels and tyres — size and capacity	25
47 Pneumatic tyres generally	25

	Page
48 Pneumatic tyres — carcass construction.....	25
49 Pneumatic tyres — size and capacity	26
50 Tyres — defects	26
51 Tyres for use on vehicles with GVM over 4.5 tonnes	26
52 Tyres — manufacturer's rating.....	26
53 Retreads	27
54 Tyre tread	28
Division 2 Additional requirements for motor bikes.....	29
55 Steering gear and handlebars.....	29
56 Foot rests	30
57 Chain guards.....	30
Part 6 Vehicle marking	31
58 Vehicle and engine identification numbers	31
59 White or silver band on certain vehicles	31
60 Warning signs for combinations over 22 metres long.....	32
61 Warning signs not to be displayed on other vehicles.....	33
62 Specifications for warning signs.....	33
63 Left-hand drive signs.....	34
Part 7 Vehicle configuration and dimensions	35
Division 1 Axles	35
64 Axle configuration.....	35
65 Relation between axles in axle group	36
Division 2 Dimensions 38	
66 Width 38	
67 Length of single motor vehicles.....	38
68 Length of single trailers	38
69 Length of combinations	39
70 Rear overhang.....	40
71 Trailer drawbar length	41
72 Height 42	
73 Ground clearance.....	42

	Page
Part 8 Lights and reflectors	44
Division 1 General requirements for lights.....	44
74 Certain requirements apply only at night	44
75 Prevention of glare	44
76 Pairs of lights.....	44
Division 2 Headlights	46
77 Headlights to be fitted to vehicles	46
78 How headlights are to be fitted.....	47
79 How single headlights are to be fitted	47
80 How additional headlights are to be fitted	47
81 Performance of headlights	47
82 Effective range of headlights.....	48
83 Changing headlights from high-beam to low-beam position.....	48
Division 3 Parking lights 49	
84 Parking lights.....	49
Division 4 Daytime running lights.....	51
85 Daytime running lights.....	51
Division 5 Tail lights.....	53
86 Tail lights generally.....	53
87 Pattern of fitting tail lights	53
88 Performance of tail lights.....	54
89 Wiring of tail lights	55
Division 6 Number plate lights.....	56
90 Number plate lights	56
Division 7 Clearance lights.....	57
91 Front clearance lights.....	57
92 External cabin lights	57
93 Rear clearance lights	58
Division 8 Side marker lights	59
94 Vehicles needing side marker lights	59
95 Location of side marker lights	59

	Page
96 Performance of side marker lights	61
97 Side marker lights and rear clearance lights.....	61
Division 9 Brake lights 62	
98 Fitting brake lights	62
99 Performance and operation of brake lights.....	63
Division 10 Reversing lights.....	65
100 Reversing lights.....	65
Division 11 Direction indicator lights	66
101 Direction indicator lights on motor vehicles.....	66
102 Direction indicator lights on trailers	66
103 Location of direction indicator lights.....	67
104 Operation and visibility of direction indicator lights	67
Division 12 Fog lights 70	
105 Front fog lights.....	70
106 Rear fog lights	70
Division 13 Interior lights 72	
107 Interior lights.....	72
Division 14 Reflectors generally	73
108 General requirements for reflectors	73
Division 15 Rear reflectors	74
109 Rear reflectors.....	74
Division 16 Side reflectors 75	
110 Compulsory side reflectors on pole-type trailers.....	75
111 Optional side reflectors	75
Division 17 Front reflectors	76
112 Compulsory front reflectors on trailers.....	76
113 Optional front reflectors.....	76
Division 18 Warning lights and signs on buses carrying children	78
114 Application of Division	78

	Page
115 Fitting of warning lights and signs	78
116 Operation and performance of warning lights	79
117 Specifications for warning signs.....	80
Division 19 Other lights, reflectors, rear marking plates or signals	82
118 Other lights and reflectors	82
119 Rear marking plates	83
120 Signalling devices.....	84
121 Mechanical signalling devices.....	85
122 Turn signals.....	85
Division 20 Vehicles not required to have lights or reflectors	87
123 Certain vehicles used in daylight.....	87
124 Certain vehicles used for collection or exhibition purposes	87
Part 9 Braking systems	88
Division 1 Brake requirements for all vehicles	88
125 Parts of a braking system.....	88
126 Provision for wear.....	89
127 Supply of air or vacuum to brakes.....	89
128 Performance of braking systems	90
Division 2 Motor vehicle braking systems.....	92
129 What braking system a motor vehicle must have	92
130 Operation of brakes on motor vehicles	93
131 Air or vacuum brakes on motor vehicles.....	93
Division 3 Trailer braking systems	95
132 What brakes a trailer must have	95
133 Operation of brakes on trailers.....	95
134 Air or vacuum brakes on trailers	95
Division 4 Additional brake requirements for B-doubles and long road trains.....	97
135 Application of Division to certain road trains	97
136 Braking system design for a prime mover in a B-double	97
137 Braking system design for motor vehicles in road trains	97
138 Braking system design for trailers in B-doubles or road trains	97

	Page
139 Air brakes of motor vehicles in B-doubles or road trains	98
140 Air brakes in a B-double or road train: least favoured chamber	99
141 Recovery of air pressure for brakes in B-doubles and road trains	99
142 Air supply for brakes in B-doubles and road trains	100
143 Brake line couplings	100
144 Simultaneous parking brake application	101
145 Capacity of air reservoirs	101
Part 10 Control of emissions	102
Division 1 Crank case gases and exhaust emissions	102
146 Crank case gases – certain petrol-powered vehicles	102
147 Visible exhaust emissions – vehicles with internal combustion engines	102
Division 2 Exhaust systems	105
148 Exhaust systems	105
Division 3 Noise emissions	108
Subdivision A General	108
148A Measurement of stationary noise levels	108
148B Meaning of <i>certified to ADR83/00</i>	108
149 Silencing device for exhaust systems	108
Subdivision B Noise levels applying to pre-2004 vehicles	109
149A Application of rules in subdivision B	109
150 Stationary noise levels — car-type vehicles and motor bikes and trikes	109
151 Stationary noise levels — other vehicles with spark ignition engines....	110
152 Stationary noise levels — other vehicles with diesel engines.....	110
Subdivision C Noise levels applying to vehicles certified to ADR 83/00	112
153 Stationary noise levels	112
Part 11 LPG fuel systems.....	113
154 LPG-powered vehicles	113
Part 12 Maximum road speed limiting	114
155 Speed limiting.....	114
156 Exemptions from speed limiting	114

	Page
Part 13 Mechanical connections between vehicles	115
Division 1 Couplings on all types of vehicles	115
157 General coupling requirements	115
158 Drawbar couplings	115
Division 2 Additional coupling requirements for B-doubles and long road trains	117
159 Application of Division to road trains	117
160 Couplings for B-doubles and road trains	117
161 Selection of fifth wheel couplings for B-doubles and road trains	117
162 D-value of a fifth wheel coupling	118
163 Mounting of fifth wheel couplings on B-doubles and road trains	118
164 Branding of fifth wheel couplings and turntables on B-doubles and road trains	118
165 Selection of kingpins for B-doubles and road trains	119
166 Attachment of kingpins on B-doubles and road trains	120
167 Branding of kingpins on B-doubles and road trains	121
168 Selection of couplings and drawbar eyes for road trains	121
169 Attachment of couplings and drawbar eyes on road trains	121
170 Branding of couplings and drawbar eyes on road trains	122
171 Tow coupling overhang on road trains	122
Part 14 Other matters	123
172 Vehicle equipment	123
173 Restored vehicles	123
174 Retractable axles	123
175 Measurement of distance between parallel lines	123
176 Interpretation of certain second edition ADRs	123

Part 1 Introductory

Division 1 General

Note The *Australian Vehicle Standards Rules 1998* set standards that vehicles must comply with to be driven on roads and road-related areas.

The ADRs (Australian Design Rules) are rules for designing and building vehicles. Imported vehicles must also comply with the ADRs.

The Vehicle Standards require a vehicle that is subject to an ADR when built or imported to continue to comply with the ADR.

The Vehicle Standards also apply certain other standards (adopted standards) that are intended to complement the ADRs.

The ADRs do not cover:

- vehicles built before 1969
- combinations of vehicles of any age
- every safety feature for vehicles built between 1969 and 1988.

These matters are covered by the Vehicle Standards.

In most cases, if a vehicle complies with the Vehicle Standards, it is suitable for road use.

1 Name of regulations

These regulations are the *Australian Vehicle Standards Rules 1998* (the *Vehicle Standards*).

2 Object of Vehicle Standards

- (1) The object of the Vehicle Standards is to set standards, about the construction and performance of motor vehicles, trailers and combinations, that are uniform throughout Australia.
- (2) The standards are intended:
 - (a) to promote, throughout the life of motor vehicles, trailers and combinations, their safe use and efficiency and the protection of the environment; and
 - (b) to reduce the cost of transport administration.

Division 2 Some features of the Vehicle Standards

3 Definitions — the dictionary etc

- (1) The dictionary at the end of the Vehicle Standards defines certain words and expressions, and includes signpost definitions to words and expressions defined elsewhere in the Vehicle Standards.

Note A signpost definition (eg *road-related area* see rule 9) is included in the dictionary if the definition applies outside the rule defining the word or expression.

- (2) The dictionary is part of the Vehicle Standards.
- (3) A definition in the Vehicle Standards applies to each use of the word or expression in the Vehicle Standards, unless the contrary intention appears.

4 Diagrams

- (1) A diagram in the Vehicle Standards is part of the Vehicle Standards.
- (2) A diagram of something (except the essential diagram in rule 165) is an illustrative example of the thing in black and white, but does not represent its dimensions or the dimensions of any part of it.

Note The essential diagram in rule 165 provides the dimensions required for a 75 millimetre kingpin used in a B-double or road train.

5 Notes

A note in the Vehicle Standards is explanatory and is not part of the Vehicle Standards.

6 Examples

- (1) An example (whether or not in the form of a diagram) in the Vehicle Standards is part of the Vehicle Standards.
- (2) If the Vehicle Standards includes an example of the operation of a provision of the Vehicle Standards:
 - (a) the example is not exhaustive; and
 - (b) the example does not limit, and may extend, the meaning of the provision; and
 - (c) the example and the provision are to be read in the context of each other and of the other provisions of the Vehicle Standards, but, if the example and the provision as so read are inconsistent, the provision prevails.

Part 2 Application of the Vehicle Standards

7 Application to vehicles and combinations on roads and road-related areas

The Vehicle Standards apply to motor vehicles, trailers and combinations on roads and road-related areas.

8 What is a road

A *road* is an area that is open to or used by the public and is developed for, or has as one of its main uses, the driving or riding of motor vehicles.

9 What is a road-related area

A *road-related area* is any of the following:

- (a) an area that divides a road;
- (b) a footpath or nature strip adjacent to a road;
- (c) an area that is open to the public and is designated for use by cyclists or animals;
- (d) an area that is not a road and that is open to or used by the public for driving, riding or parking vehicles.

10 Vehicles to which the Vehicle Standards do not apply

The Vehicle Standards do not apply to:

- (a) a vehicle used only on a railway or tramway; or
- (b) a vehicle designed to be controlled by a person walking next to it; or
- (c) a vehicle propelled by a motor with a maximum power output of not over 200 watts; or
- (d) a motorised wheelchair that cannot travel at over 10 kilometres an hour; or

- (e) a vehicle or combination that is being repaired, or is being tested in the course of being repaired, so it will comply with the Vehicle Standards; or
- (f) a vehicle or combination being driven or towed directly to a place where it is to be repaired so it will comply with the Vehicle Standards.

11 Non-application of Vehicle Standards — exemption under other laws

- (1) A provision of the Vehicle Standards does not apply to a vehicle or combination if the vehicle or combination is exempt from:
 - (a) the provision under another law of this jurisdiction; or
 - (b) the corresponding provision of the law of another jurisdiction.
- (2) However, the vehicle or combination is exempt only if all conditions of the exemption (if any) are being complied with.

Example

An exemption permitting a greater dimension limit for a vehicle is subject to conditions about the route where, and times when, the vehicle is permitted to travel, and the escort vehicles required to accompany the vehicle. A relevant provision of the Vehicle Standards does not apply to the vehicle only if the conditions are complied with.

12 Non-application of Vehicle Standards — inconsistent ADR requirements

A provision of Parts 5 to 13 of the Vehicle Standards does not apply to a vehicle if:

- (a) the provision is inconsistent with a requirement of a second or third edition ADR applying to the vehicle; and
- (b) the vehicle complies with the requirement.

13 Non-application of Vehicle Standards — Motor Vehicle Standards Act approvals

A provision of Parts 5 to 13 of the Vehicle Standards does not apply to a vehicle if:

- (a) the vehicle does not comply with a requirement of an ADR applying to the vehicle; and
- (b) the provision of the Vehicle Standards corresponds to the requirement of the ADR; and
- (c) despite the non-compliance, approval has been given, under section 10A (2) or (3) of the *Motor Vehicle Standards Act 1989* of the Commonwealth, to place identification plates on vehicles of that type; and
- (d) the vehicle complies with the approval conditions (if any).

Note 1 Section 10A (2) of the *Motor Vehicle Standards Act 1989* (Cwlth) deals with vehicles that do not comply with an ADR, but the non-compliance is only in minor and inconsequential respects.

Note 2 Section 10A (3) of that Act deals with vehicles that do not comply with an ADR, and the non-compliance is not minor and inconsequential, but the vehicle will be safe to use if conditions are complied with.

Part 3 Australian Design Rules

Note This Part applies the second and third edition ADRs to various vehicles.

Under the Part, a vehicle that is subject to ADRs when it is built generally remains subject to the ADRs throughout its life. However, a vehicle need not comply with a standard if the standard is replaced by, or inconsistent with, a later standard and the vehicle complies with the later standard. Older vehicles may, therefore, be fitted with any equipment allowed on newer vehicles.

Vehicles that are modified must continue to comply with the Vehicle Standards. For guidance on vehicle modifications see *Vehicle Standards Bulletin No. 6 - Heavy Vehicle Modifications* and *Vehicle Standards Bulletin No. 14 - Light Vehicle Modifications*.

Note third para.
substituted by
Item 4

(See <http://www.dotars.gov.au/transreg/vsb/index.aspx>)

Rule 34 (6) (horns, alarms etc) of the Vehicle Standards modifies the effect of the corresponding ADR requirement.

The following provisions of the Vehicle Standards extend the application of particular second or third edition ADRs to vehicles to which the ADRs are not expressed to apply:

- subrule 41 (4) (electrical wiring, components, connections and installations)
- rule 119 (rear marking plates)
- rule 136 (1) and (2) (braking system for prime mover in B-double)
- rule 137 (braking system design for motor vehicles in road trains)
- rule 138 (1) and (3) (braking system design for trailers in B-doubles or road trains)
- rule 155 (1) and (2) (speed limiting).

Note, subrule
41(4) substituted
by Item 4

The following provisions of the Vehicle Standards apply to a vehicle instead of the corresponding ADR requirement:

- rule 44 (5) and (6) (window tinting)
- rules 51 and 52 (tyre speed category requirements)
- rule 115 (warning lights and signs on buses carrying children)
- rule 118 (4) (display of certain lights and reflectors)
- Subrule 169(b) (attachment of couplings and drawbar eyes on road trains).

Note, subrule
169(b) inserted by
Item 4

Division 1 Interpretation

14 What is an ADR

An *ADR* (Australian Design Rule) is a national standard.

15 What is a national standard

A *national standard* is a national standard under the *Motor Vehicle Standards Act 1989* of the Commonwealth.

16 References to national standards

Unless the contrary intention appears, a reference in the Vehicle Standards to a national standard is a reference to the national standard as in force from time to time.

17 What is a second edition ADR

A *second edition ADR* is a national standard incorporated in the document described as the *Australian Design Rules for Motor Vehicle Safety, Second Edition* originally published by the then Commonwealth Department of Transport.

18 What is a third edition ADR

A *third edition ADR* is a national standard incorporated in the document described as the *Australian Design Rules for Motor Vehicles and Trailers, Third Edition* published by the Federal Office of Road Safety of the Commonwealth Department of Transport and Regional Development.

Division 2 Compliance with ADRs

19 Compliance with second edition ADRs

- (1) If a second edition ADR recommends that the ADR should apply to the design and construction of a vehicle, the vehicle must comply with the ADR.
- (2) If a second edition ADR contains a requirement for a type of equipment fitted to a vehicle built on or after a stated time any equipment of the same type fitted to the vehicle after it is built must comply with:
 - (a) the requirement as in force when the vehicle was built; or
 - (b) if the requirement is amended after the vehicle is built and before the equipment is fitted — the requirement as in force:
 - (i) when the vehicle was built; or
 - (ii) when the equipment was fitted; or
 - (iii) at any time between when the vehicle was built and the equipment was fitted.
- (3) However, a vehicle, or equipment fitted to a vehicle, need not comply with a recommendation or requirement of a second edition ADR if:
 - (a) the recommendation or requirement is replaced by, or is inconsistent with, a requirement of a third edition ADR applying to the vehicle or equipment; and
 - (b) the vehicle or equipment complies with the requirement of the third edition ADR.
- (4) If a second edition ADR allows a vehicle built on or after a stated time to be fitted with equipment, a vehicle built before the time may also be fitted with the equipment.

20 Compliance with third edition ADRs

- (1) If a third edition ADR applies to the design and construction of a vehicle, the vehicle must comply with the ADR.
- (2) If a third edition ADR contains a requirement for a type of equipment fitted to a vehicle built on or after a stated time, any equipment of the same type fitted to the vehicle after it is built must comply with:
 - (a) the requirement as in force when the vehicle was built; or
 - (b) if the requirement is amended after the vehicle is built and before the equipment is fitted — the requirement as in force:
 - (i) when the vehicle was built; or
 - (ii) when the equipment was fitted; or
 - (iii) at any time between when the vehicle was built and the equipment was fitted.
- (3) However, a vehicle, or equipment fitted to a vehicle, need not comply with a requirement of a third edition ADR if:
 - (a) the requirement is replaced by, or is inconsistent with, a requirement of a later version of the ADR applying to the vehicle or equipment; and
 - (b) the vehicle or equipment complies with the requirement of the later version.
- (4) If a third edition ADR allows a vehicle built on or after a stated time to be fitted with equipment, a vehicle built before the time may also be fitted with the equipment.

21 Exception to compliance with ADRs — vehicles that are not road vehicles

A vehicle need not comply with an ADR applied by rule 19 (1) or 20 (1) if a determination or declaration under section 5B of the *Motor Vehicle Standards Act 1989* of the Commonwealth provides that the vehicle is not a road vehicle for that Act.

22 Exception to compliance with ADRs — Motor Vehicle Standards Act

- (1) A vehicle need not comply with an ADR applied by rule 19 (1) or 20 (1) if:
- (a) despite non-compliance with the ADR, approval has been given, under section 10A (2) or (3) of the *Motor Vehicle Standards Act 1989* of the Commonwealth, to place identification plates on vehicles of that type; and
 - (b) the vehicle complies with the approval conditions (if any).
- Note* See notes to rule 13.
- (2) A vehicle need not comply with an ADR applied by rule 19 (1) or 20 (1) if:
- (a) the vehicle may be supplied to the market under subsection 14A (1) of the *Motor Vehicle Standards Act 1989* of the Commonwealth; and
 - (b) for a vehicle for which an approval has been given under that subsection — the vehicle complies with the approval conditions (if any).
- (3) A vehicle need not comply with an ADR applied by rule 19 (1) or 20 (1) if:
- (a) the vehicle may be used in transport in Australia under subsection 15 (2) of the *Motor Vehicle Standards Act 1989* of the Commonwealth; and
 - (b) for a vehicle for which an approval has been given under that subsection — the vehicle complies with the approval conditions (if any).

23 Partial exception to compliance with ADRs — personally imported vehicles

- (1) For this rule, a *personally imported vehicle* is a vehicle built after 1968 that is imported into Australia under regulation 13 of the *Motor Vehicle Standards Regulations 1989* by a person who owned and used the vehicle for a continuous period of at least:
 - (a) for a vehicle owned by the applicant before 9 May 2000 — 3 months; or
 - (b) in any other case — 12 months;
before it was imported into Australia.
- (2) A personally imported vehicle must be fitted with:
 - (a) seat belts that are as effective as seat belts that meet an Australian Standard or British Standard for seat belts as in force when this rule commenced; and
 - (b) seat belt anchorages that meet the number and location requirements of second or third edition ADR 5; and
 - (c) child restraint anchorages that meet the number, location, accessibility, thread size and form requirements of second edition ADR 34 or third edition ADR 5 or 34; and
 - (d) head restraints that meet the number, location and size requirements of second or third edition ADR 22.
- (3) However, a personally imported vehicle need only meet the requirements of an ADR mentioned in subrule (2) if the ADR recommends that it should apply, or applies, to a vehicle of the same type.
- (4) A personally imported vehicle need not otherwise comply with an ADR applied by rule 19 (1) or 20 (1).

Rule 23(1) substituted by Item 4
--

Part 4 **Adopted standards**

24 What is an adopted standard

An *adopted standard* is a standard, except a national standard, that is applied, adopted or incorporated by the Vehicle Standards.

Example

Rule 62 (7) adopts Australian Standard AS 1906 *Retro-reflective Materials and Devices for Road Traffic Control Purposes*.

25 Reference to adopted standards

Unless the contrary intention appears, a reference in a rule or subrule to an adopted standard is a reference to the standard as in force when the rule or subrule commenced.

26 Exception to compliance with adopted standards

A vehicle need not comply with an adopted standard if:

- (a) the standard is replaced by, or is inconsistent with, a later version of the standard; and
- (b) the vehicle complies with the later version of the standard.

Part 5 General safety requirements

Note For a vehicle to be operated safely, the vehicle needs to be properly designed to minimise the potential for accidents and harm to other road users.

This Part sets out various requirements covering the driver's view from a vehicle, the driver's control of a vehicle, protection of vehicle occupants and other road users, and other general safety features.

Division 1 All vehicles

27 Steering

- (1) A motor vehicle with a GVM over 4.5 tonnes must have a right-hand drive.
- (2) A motor vehicle with a GVM not over 4.5 tonnes must have a right-hand drive if the vehicle:
 - (a) is less than 30 years old; and
 - (b) is required under a law of this jurisdiction to have a right-hand drive.
- (3) A motor vehicle has a right-hand drive if the centre of at least 1 steering control of the vehicle is to the right of, or in line with, the centre of the vehicle.
- (4) A component of the steering system of a motor vehicle that is essential for effective steering of the vehicle must be built to transmit energy by mechanical means only.
- (5) Failure of a non-mechanical component of the steering system must not prevent effective steering of the vehicle.
- (6) This rule does not apply to a vehicle if the vehicle is built mainly for a purpose other than the transport of goods or people by road.

Rule 27(6) amended by Item 4

28 Turning ability

- (1) A motor vehicle must be able to turn in a circle not over 25 metres in diameter, measured by the outer edge of the tyre track at ground level.
- (2) The vehicle must be able to comply with subrule (1) whether it turns to the left or to the right.

29 Ability to travel backwards and forwards

A motor vehicle with an unloaded mass over 450 kilograms must be able to be driven both backwards and forwards when the driver is in the normal driving position.

30 Protrusions

- (1) An object fitted to a vehicle must be designed, built and fitted to the vehicle in a way that minimises the likelihood of injury to a person making contact with the vehicle.
- (2) However, subrule (1) does not apply to an object fitted to a vehicle if:
 - (a) the vehicle was designed before 1965 and the object was part of the design of the vehicle; or
 - (b) the object was fitted to the vehicle before 1965 in accordance with the law of the place where the object was fitted.

31 Driver's view and vehicle controls

A motor vehicle must be built:

- (a) to allow the driver a view of the road and of traffic to the front and sides of the vehicle so the driver can drive the vehicle safely; and
- (b) with its controls located so the driver can drive the vehicle safely.

32 Seating

A seat for a driver or passenger in a vehicle must be securely attached to the vehicle.

33 Mudguards and spray suppression

- (1) A vehicle must have firmly fitted:
- (a) a mudguard for each wheel or for adjacent wheels; and
 - (b) for each axle group and single axle on a vehicle that is part of a B-double — spray suppression devices complying with Parts 1 and 2 of British Standard AU200-1984 *Spray Reducing Devices for Heavy Goods Vehicle*.
- (2) However, subrule (1) (a) does not apply to a vehicle if:
- (a) the construction or use of the vehicle makes the fitting of mudguards unnecessary or impracticable; or
 - (b) the body or part of the body of the vehicle acts as a mudguard.

Examples of vehicles to which subrule (2) (a) applies

- 1. Timber jinkers.
 - 2. Most road-making plant.
 - 3. Some agricultural equipment.
- (3) A mudguard fitted to a vehicle with a GVM over 4.5 tonnes must, when the wheels of the vehicle are in position to move straight ahead:
- (a) reduce the danger of a person contacting the moving wheels; and
 - (b) for the rear wheels:
 - (i) cover the overall tyre width of the wheel or wheels to which it is fitted; and
 - (ii) be fitted so the height above ground level of the lowest edge of the rear of the mudguard is not over one-third of the horizontal distance between the edge and the centre of the rearmost axle.
- (4) However, a mudguard may be up to:
- (a) 230 millimetres above ground level; or

- (b) on a vehicle built to be used off road — 300 millimetres above ground level.
- (5) The outside of a rear mudguard, except a mudflap, of a vehicle that can be seen from the rear of the vehicle must be coloured white or silver if the vehicle:
 - (a) is at least 2.2 metres wide; and
 - (b) has a body the vertical measurement of which is under 300 millimetres at the rear, measured from the lowest point of the body above ground level to the highest point; and
 - (c) is not fitted with rear marking plates in accordance with rule 119.
- (6) For subrule (5)(a), the width of a vehicle is measured disregarding any anti-skid device mounted on wheels, central tyre inflation systems, lights, mirrors, reflectors, signalling devices and tyre pressure gauges.

34 Horns, alarms etc

- (1) A motor vehicle must be fitted with at least 1 horn or other device that can give sufficient audible warning to other road users of the approach or position of the vehicle.
- (2) A motor vehicle must not be fitted with a device that can make a sound like the sound of a siren, exhaust whistle, compression whistle or repeater horn.
- (3) However, subrule (2) does not apply to:
 - (a) a police vehicle; or
 - (b) an emergency vehicle; or
 - (c) a transport enforcement vehicle; or
 - (d) an Australian Protective Service vehicle; or
 - (e) an Australian Customs Service vehicle; or
 - (f) an Airservices Australia vehicle; or
 - (g) a vehicle at least 25 years old that is fitted as a police or emergency vehicle if:
 - (i) the vehicle is used for exhibition purposes; or

Rule 34(2) amended by Item 4

- (ii) it is part of a collection of former police or emergency vehicles; or
 - (h) an anti-theft alarm if the alarm cannot be operated while the vehicle's ignition is on.
- (4) Also, a motor vehicle may be fitted with a device that emits a regular, intermittent sound while the vehicle is reversing or in reverse gear.
- (5) The device must not be louder than is necessary so the driver, and a person near the vehicle, can hear the device when it is operating.
- (6) The provision of the relevant ADR that corresponds to subrule (2) applies to a vehicle as if that provision did not contain a reference to a bell.

Rule 34(6) inserted by Item 4

35 Rear vision mirrors

- (1) A rear vision mirror or mirrors must be fitted to a motor vehicle as required by this rule so that a driver of the vehicle can clearly see by reflection the road behind the vehicle and any following or overtaking vehicle.
- (2) At least 1 rear vision mirror must be fitted to:
- (a) a car; and
 - (b) a motor trike with 2 front wheels; and
 - (c) a motor bike, or motor trike with 1 front wheel, built before July 1975.
- (3) At least 1 rear vision mirror must be fitted to each side of:
- (a) a motor vehicle with a GVM over 3.5 tonnes; and
 - (b) a motor bike, or motor trike with 1 front wheel, built after June 1975.
- (4) A motor vehicle with a GVM not over 3.5 tonnes (except a motor vehicle mentioned in subrule (2) or (3)) must be fitted with:
- (a) at least 1 rear vision mirror on the right side of the vehicle; and

- (b) at least 1 rear vision mirror on the left side of the vehicle or inside the vehicle.
- (5) A rear vision mirror fitted to a motor vehicle with a GVM over 3.5 tonnes must not project over 150 millimetres beyond the widest part (excluding lights, signalling devices and reflectors) of the vehicle or combination.
- (6) However, the rear vision mirror may project not over 230 millimetres beyond the widest part of the vehicle or combination if it can fold to project not over 150 millimetres beyond the widest part.

36 Rear vision mirrors — surfaces

- (1) A rear vision mirror required to be fitted to the side of a motor vehicle with a GVM over 3.5 tonnes must have a reflecting surface of at least 150 square centimetres.
- (2) A rear vision mirror required to be fitted to the right side of a motor vehicle with a GVM over 3.5 tonnes must have a flat reflecting surface if:
 - (a) the motor vehicle has only 1 steering control; and
 - (b) the centre of the steering control is to the right of, or in line with, the centre of the motor vehicle.
- (3) The reflecting surface of the rear vision mirrors that are required to be fitted to a motor bike or moped must:
 - (a) each be of the same curvature; and
 - (b) if convex, be part of a notional sphere with a radius of at least 1.2 metres.

37 Additional rear vision mirrors

A motor vehicle may be fitted with additional rear vision mirrors or mirror surfaces that are flat or convex or a combination of flat and convex surfaces.

38 Automatic transmission

- (1) A motor vehicle fitted with an automatic transmission must have an engine starter mechanism that cannot operate when the transmission control is in a position to drive the vehicle.
- (2) A vehicle built after 1975 that is fitted with an automatic transmission must have an indicator in the driver's compartment showing the transmission control position.
- (3) Subrules (1) and (2) do not apply to a motor vehicle with less than 4 wheels.

39 Diesel engines

A motor vehicle propelled by a compression ignition engine (commonly known as a diesel engine) must be fitted with a device preventing the engine from being started accidentally or inadvertently.

40 Bonnet securing devices

- (1) A motor vehicle with a moveable body panel forward of the windscreen that covers an engine or luggage storage or battery compartment, must have a device to secure the panel.
- (2) However, if the panel opens from the front in a way that partly or completely obstructs the driver's forward view through the windscreen, the panel must have primary and secondary devices to secure the panel.

41 Electrical wiring, components, connections and installations

- (1) The wiring of electrical equipment of a vehicle, except the high tension ignition wiring, must:
 - (a) be supported at intervals of not over 600 millimetres, unless the vehicle is a pole-type trailer with a pole with an adjustable length, or an extendible trailer; and
 - (b) be insulated at each of its joints; and

Rule 41 heading substituted by Item 4

- (c) be located where it cannot:
 - (i) become overheated; or
 - (ii) contact moving parts; or
 - (iii) come near enough to the fuel system to be a fire hazard; and
 - (d) be protected from chafing.
- (1A) The electrical components of a vehicle must be securely mounted.
- (2) The electrical connectors between motor vehicles and trailers, for operation of the vehicle lights required by the Vehicle Standards, must comply with Australian Standard AS 2513-1982 *Electrical Connections for Trailer Vehicles*.
- (3) A trailer must be equipped with an electrical conductor, independent of the trailer coupling, that provides a return path between the electrical circuits of the trailer and towing vehicle.
- (4) The electrical wiring, connections and installations of a semi-trailer, dog trailer or converter dolly used in a road train over 19 metres long after June 1998 must comply with third edition ADR 63, whether or not it was built before the date stated in the ADR for vehicles of that type.

Rule 41(1A) inserted by Item 4

42 Television receivers and visual display units

- (1) A television receiver or visual display unit must not be installed in a vehicle so any part of the image on the screen is visible to the driver from the normal driving position.
- (2) However, subrule (1) does not apply to:
- (a) a television receiver or visual display unit that cannot be operated when the vehicle is moving; or
 - (b) a driver's aid in any vehicle or a destination sign in a bus.

Examples of driver's aids

1. Closed-circuit television security cameras.
2. Dispatch systems.
3. Navigational or intelligent highway and vehicle system equipment.
4. Rearview screens.

5. Ticket-issuing machines.
 6. Vehicle monitoring devices.
- (3) A television receiver, or visual display unit, and its associated equipment in a vehicle must be securely mounted in a position that:
- (a) does not obscure the driver's view of the road; and
 - (b) does not impede the movement of a person in the vehicle.

42A Requirement for windscreen to be fitted

Rule 42A inserted
by Item 4

A motor vehicle (but not including a motor bike, a motor trike or a moped) must be fitted with a windscreen if it is manufactured or designed to have a windscreen.

43 Windscreens and windows

- (1) Transparent material used in a windscreen, window, or an interior partition, of a motor vehicle must be of approved material if:
- (a) the vehicle was built after June 1953; or
 - (b) the material was first fitted to the vehicle after June 1953.

- (2) In this rule:

approved material means material with the same characteristics as material mentioned in any of the following standards:

- Australian Standard AS R1-1965 *Safety Glass for Land Transport*
- Australian Standard AS R1-1968 *Safety Glass for Land Transport*
- Australian Standard AS 2080-1977 *Safety Glass for Vehicles*
- British Standard BS 857:1967 *Specification for Safety Glass for Land Transport*
- British Standard BS 5282:1975 *Road Vehicle Safety Glass*
- British Standard BS AU178:1980 *Road Vehicle Safety Glass*

- Japanese Industrial Standard JIS R 3211-1979 *Safety Glasses for Road Vehicles*
- American National Standard ANSI Z26.1-1980 *Safety Code for Safety Glazing Materials for Glazing Motor Vehicles Operating on Land Highway*.

transparent material does not include any coating added to the windscreen, window or partition after its manufacture.

44 Window tinting

- (1) Glazing used in a windscreen of a motor vehicle must have a luminous transmittance of at least:
 - (a) for a motor vehicle built after 1971 — 75%; or
 - (b) for another motor vehicle — 70%.
- (2) Windscreen glazing of a motor vehicle must not be coated in a way that reduces its luminous transmittance.
- (3) However, subrules (1) and (2) do not apply to the greater of the following areas of a windscreen:
 - (a) the area above the highest point of the windscreen that is swept by a windscreen wiper;
 - (b) the upper 10% of the windscreen.
- (4) Glazing used in a window or interior partition of a motor vehicle must have a luminous transmittance of at least 70%.
- (5) Glazing behind the rear of the driver's seat may be coated to achieve a luminous transmittance of not less than 35%.
- (6) Glazing in a side window forward of the rear of the driver's seat may be coated to achieve a luminous transmittance of not less than 70% or, if another law of this jurisdiction allows a lesser luminous transmittance, the greater of:
 - (a) the lesser luminous transmittance allowed under the other law; and
 - (b) 35%.
- (7) Glazing that has been coated to reduce its luminous transmittance must not have a reflectance of over 10%.

(8) The luminous transmittance requirements in subrules (5) and (6) apply to a vehicle instead of the corresponding requirements in the relevant ADR.

(9) In this rule:

glazing means material fitted to the front, sides, rear or interior of a vehicle, through which the driver can see the road, but does not include a coating added after manufacture of the material.

luminous transmittance, for glazing, means the amount of light that can pass through the glazing as a percentage of the amount of light that would be transmitted if the glazing were absent.

45 **Windscreen wipers and washers**

(1) A motor vehicle with 3 or more wheels that is fitted with a windscreen must be fitted with at least 1 windscreen wiper unless a driver in a normal driving position can obtain an adequate view of the road ahead of the motor vehicle without looking through the windscreen.

(2) At least 1 windscreen wiper fitted to the motor vehicle must:

(a) be able to remove moisture from the part of the windscreen in front of the driver to allow the driver an adequate view of the road ahead of the motor vehicle when the windscreen is wet; and

(b) be able to be operated from a normal driving position; and

(c) for a motor vehicle built after 1934 — continue to operate until the wiper is switched off; and

(d) for a motor vehicle built after 1959 the driving position of which is nearer one side of the vehicle than the other:

(i) be able to remove moisture from the part of the windscreen in front of the driver, and a corresponding part of the windscreen on the other side of the centre of the motor vehicle, to allow the driver an adequate view of the road ahead of the motor vehicle when the windscreen is wet; and

- (ii) if the windscreen wipers are operated by engine manifold vacuum — be provided with a vacuum reservoir or pump to maintain the efficient operation of the wiper or wipers while the vehicle is in motion.
- (3) If the motor vehicle was built after 1982 and has a GVM over 4.5 tonnes, it must also be fitted with a windscreen washer that can direct water onto the windscreen within the area swept by a windscreen wiper so the wiper can spread the water to all of the area swept by the wiper.

Note The ADRs require certain vehicles with a GVM not over 4.5 tonnes to be fitted with a windscreen washer.

- (4) The windscreen washer must be able to be operated from a normal driving position.

46 Wheels and tyres — size and capacity

The wheels and tyres fitted to an axle of a vehicle must be of sufficient size and capacity to carry the part of the vehicle's gross mass transmitted to the ground through the axle.

47 Pneumatic tyres generally

A vehicle built after 1932 must be fitted with pneumatic tyres.

48 Pneumatic tyres — carcass construction

- (1) A vehicle with a GVM not over 4.5 tonnes must not have pneumatic tyres of different carcass construction fitted to the same axle, but the tyres may have different cord materials and a different number of plies.
- (2) However, subrule (1) does not apply to a tyre being used in an emergency as a temporary replacement for a tyre complying with the subrule.

49 Pneumatic tyres — size and capacity

The size and capacity of a pneumatic tyre to be fitted to a vehicle must be decided using a cold inflation pressure that is not more than the lesser of:

- (a) the pressure recommended by the tyre manufacturer; and
- (b) a pressure of:
 - (i) for a radial ply tyre — 825 kilopascals; or
 - (ii) for another tyre — 700 kilopascals.

50 Tyres — defects

A tyre fitted to a vehicle must be free of any apparent defect that could make the vehicle unsafe.

51 Tyres for use on vehicles with GVM over 4.5 tonnes

- (1) A tyre fitted to a vehicle with a GVM over 4.5 tonnes must be suitable for road use at the lesser of:
 - (a) 100 kilometres an hour; and
 - (b) the vehicle's top speed.
- (2) This rule applies to a vehicle instead of the tyre speed category requirements in the relevant ADR.

52 Tyres — manufacturer's rating

- (1) This rule applies to a motor vehicle if the vehicle:
 - (a) has 4 or more wheels; and
 - (b) was built after 1972; and
 - (c) has a GVM not over 4.5 tonnes.
- (2) However, this rule does not apply to a tyre if the tyre:
 - (a) is recommended by the vehicle builder as suitable for limited use on the vehicle in special circumstances at a speed less than the speed applying to the vehicle under subrule (3); or

- (b) is being used in an emergency as a temporary replacement for a tyre complying with this rule.
- (3) A tyre fitted to a motor vehicle must, when first manufactured, have been rated by the tyre manufacturer as suitable for road use at the lesser of:
 - (a) a speed of at least:
 - (i) for a car with special features for off-road use — 140 kilometres an hour; or
 - (ii) for another car — 180 kilometres an hour; or
 - (iii) for another motor vehicle — 120 kilometres an hour; and
 - (b) the vehicle's top speed.

Example for paragraph (a) (i)
A four-wheel drive vehicle.
- (4) This rule applies to a vehicle instead of the tyre speed category requirements in the relevant ADR.

53 Retreads

- (1) A tyre that is retreaded before the commencement of this rule must not be used on a vehicle if:
 - (a) Australian Standard AS 1973-1976 *Retreaded Pneumatic Passenger Car and Light Truck Tyre* or Australian Standard AS 1973-1985 *Retreaded Pneumatic Passenger and Light Truck Tyre* applies to the tyre; and
 - (b) the tyre was retreaded after publication of the Australian Standard; and
 - (c) the tyre was not retreaded in accordance with Australian Standard AS 1973-1976 *Retreaded Pneumatic Passenger Car and Light Truck Tyre*, Australian Standard AS 1973-1985 *Retreaded Pneumatic Passenger and Light Truck Tyre* or Australian Standard AS 1973-1993 *Pneumatic Tyres — Passenger Car, Light Truck and Truck/Bus — Retreading and Repair Processes*.

- (2) A tyre that is retreaded after the commencement of this rule must not be used on a vehicle if:
- (a) Australian Standard AS 1973-1993 *Pneumatic Tyres — Passenger Car, Light Truck and Truck/Bus — Retreading and Repair Processes* applies to the tyre; and
 - (b) the tyre was not retreaded in accordance with the Australian Standard.

Note The Australian Standards mentioned in this rule require various markings on retreaded tyres. These may include a speed rating less than the rating originally marked on the tyre.

54 Tyre tread

- (1) A tyre on a motor vehicle must not have cleats or other gripping devices that could damage road surfaces.
- (2) Except at tread wear indicators, a tyre fitted to the vehicle must have a tread pattern at least 1.5 millimetres deep in a band that runs continuously:
 - (a) across:
 - (i) for a vehicle with a GVM over 4.5 tonnes — at least 75% of the tyre width that normally comes into contact with the road; or
 - (ii) for another vehicle — the tyre width that normally comes into contact with the road; and
 - (b) around the whole circumference of the tyre.
- (3) A vehicle must not be fitted with a tyre that has been treated by recutting or regrooving the tread rubber, unless the tyre was:
 - (a) constructed with an extra thickness of rubber designed for recutting or regrooving; and
 - (b) labelled to indicate the construction.

Division 2 Additional requirements for motor bikes

55 Steering gear and handlebars

- (1) The handlebars on a motor bike must extend at least 250 millimetres, but not over 450 millimetres, on each side of the centre line of the vehicle.
- (2) In taking a measurement for subrule (1), mirrors and lights mounted on the handlebars of the motor bike are disregarded.
- (3) The lowest part of the hand grip on the handle bars must not be higher than 380 millimetres above the attachment point of the handlebars to the motor bike.
- (4) Hand grips on the handle bars must be fitted symmetrically.
- (5) If a motor bike has the head stem as the steering pivot point, the horizontal distance from the midpoint between the head stem bearings to the centre of the front wheel must not be over 550 millimetres.

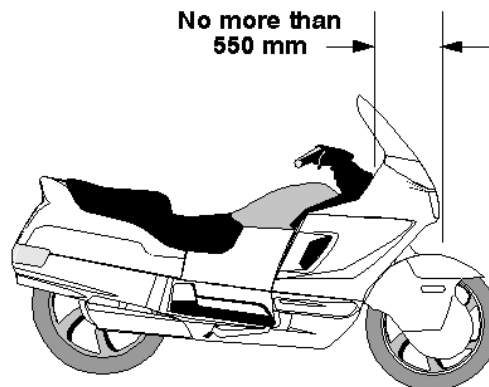

Maximum horizontal distance from midpoint between head stem bearings of motor bike to centre of front wheel

56 Foot rests

A motor bike must be fitted with foot rests for the driver, and for any passenger for whom a seating position is provided.

57 Chain guards

- (1) If the engine power of a motor bike is transmitted to the rear wheel by a chain, the driver and any passenger must be protected from the front sprocket and at least the upper part of the chain by:
 - (a) the frame or equipment of the motor bike; or
 - (b) a chain guard.
- (2) A chain guard must cover the chain to a point:
 - (a) at least 300 millimetres to the rear of the rearmost foot rest; or
 - (b) above the centre of the rear drive sprocket.

Part 6 Vehicle marking

Note This Part contains requirements for a vehicle that help to identify the vehicle and, if the vehicle is unusually long, to warn other motorists.

58 Vehicle and engine identification numbers

- (1) In this rule:
number includes letter.
- (2) A motor vehicle must have an individual engine identification number clearly stamped, embossed or otherwise permanently marked on it.
- (3) A motor vehicle built after 1930 must have the engine identification number on its engine block or the main component of its engine.
- (4) A vehicle must have an individual vehicle identification number clearly stamped, embossed or otherwise permanently marked on a substantial part of its frame or chassis.
- (5) A vehicle or engine identification number must be located where a person can read it easily without having to use tools to remove a part of the vehicle that would otherwise obstruct the person's view.

59 White or silver band on certain vehicles

- (1) This rule applies to a vehicle that:
 - (a) is at least 2.2 metres wide; and
 - (b) has a body with a vertical measurement under 300 millimetres at the rear, measured from the lowest point of the body above ground level to the highest point; and
 - (c) is not fitted with rear marking plates in accordance with rule 119.

- (2) For subrule (1)(a), the width of a vehicle is measured disregarding any anti-skid device mounted on wheels, central tyre inflation systems, lights, mirrors, reflectors, signalling devices and tyre pressure gauges.
- (3) The vehicle must have a white or silver band at least 75 millimetres high across the full width of the rearmost part of the body of the vehicle.

60 Warning signs for combinations over 22 metres long

- (1) The following vehicles must display road train warning signs complying with this rule and rule 62:
 - (a) a combination over 36.5 metres long;
 - (b) a road train over 30 metres, but not over 36.5 metres, long that includes 1 or more dog trailers.
- (2) The following vehicles must display road train warning signs, or a long vehicle warning sign, complying with this rule and rule 62:
 - (a) a road train over 22 metres, but not over 30 metres, long that includes 1 or more dog trailers;
 - (b) a road train over 22 metres, but not over 36.5 metres, long that does not include a dog trailer.
- (3) Another combination over 22 metres, but not over 36.5 metres, long must display a long vehicle warning sign complying with this rule and rule 62.
- (4) Subrules (1), (2) and (3) do not apply to the extent of any inconsistency with a notice or permit issued under another law of this jurisdiction that applies to the combination.
- (5) Road train warning signs must be used in pairs and fitted horizontally, one at the front and the other at the rear of the combination.
- (6) A long vehicle warning sign must be fitted horizontally at the rear of the combination.

61 Warning signs not to be displayed on other vehicles

- (1) A road train warning sign must not be displayed on a vehicle unless the vehicle is part of a combination or road train mentioned in rule 60 (1) or (2).
- (2) A long vehicle warning sign must not be displayed on a vehicle unless the vehicle is a part of a combination or road train mentioned in rule 60 (2) or (3).

62 Specifications for warning signs

- (1) A road train or long vehicle warning sign must be manufactured in 1 or 2 parts from sheet steel 0.8 millimetres thick or another material of at least the same stiffness, unless it is designed to be fixed to a vehicle using an adhesive.
- (2) The warning sign must be at least 1.02 metres wide and at least 250 millimetres high.
- (3) A road train warning sign must display the words 'road train', and a long vehicle warning sign must display the words 'long vehicle', in black capital letters at least 180 millimetres high in typeface Series B (N) that complies with Australian Standard AS 1744 *Forms of Letters and Numerals for Road Signs*.
- (4) If the warning sign is in 2 parts, one word of the expression 'road train' or 'long vehicle' must be on one part and the other word of the expression must be on the other part.
- (5) The warning sign must display the sign manufacturer's name or logo, and the brand and class of retro-reflective material used, in block letters not over 10 millimetres high.
- (6) The warning sign must have a black border.
- (7) The warning sign must be coated with yellow retro-reflective material of class 1 or 2 that meets Australian Standard AS 1906 *Retro-reflective Materials and Devices for Road Traffic Control Purposes*.

- (8) The warning sign must be fitted so:
- (a) no part of the sign is:
 - (i) over 1.8 metres above ground level; or
 - (ii) under 500 millimetres above ground level; and
 - (b) if the sign is in 2 parts — the parts are fitted at the same height above ground level.

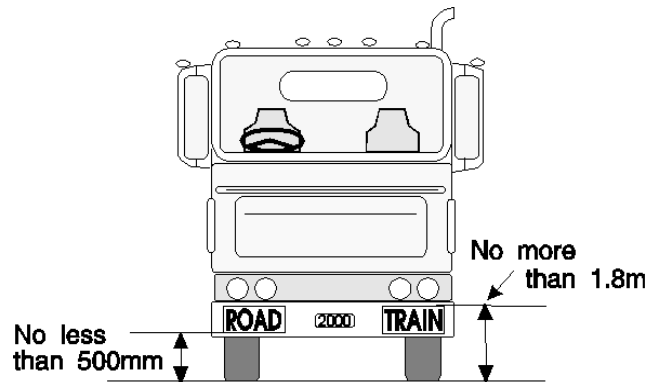

Positioning of a warning sign

63 Left-hand drive signs

- (1) This rule applies to a motor vehicle with a GVM over 4.5 tonnes that has the centre of a steering control to the left of the centre of the vehicle.
- (2) The vehicle must display the words 'left hand drive' on the rear of the vehicle.
- (3) The words must be in letters at least 75 millimetres high, and in a colour contrast with the background to the words.

Part 7 Vehicle configuration and dimensions

Note This Part sets out various requirements covering the suspension on vehicles and size limits for single vehicles and combinations of vehicles, so that they can be operated safely with other traffic, without taking up too much road space or damaging the road and structures on the road.

Generally, the limits in this Part apply to a vehicle and any load it may be carrying.

Specific requirements for loaded vehicles are covered by other laws.

Division 1 Axles

64 Axle configuration

- (1) A motor vehicle, except an articulated bus, must have only:
 - (a) 1 axle group, or single axle, towards the front of the vehicle; and
 - (b) 1 axle group, or single axle, towards the rear of the vehicle.
- (2) An articulated bus must have:
 - (a) on its front section:
 - (i) only 1 axle group, or single axle, towards the front of the section; and
 - (ii) only 1 axle group, or single axle, towards the rear of the section; and
 - (b) on another section — only 1 axle group or single axle.
- (3) A trailer must have only:
 - (a) 1 axle group or single axle; or
 - (b) 2 axle groups, 2 single axles, or 1 axle group and single axle, in the following configuration:
 - (i) 1 axle group, or single axle, towards the front of the vehicle, with all the wheels on the axle group or single axle connected to the steering mechanism for that part of the trailer;

- (ii) 1 axle group, or single axle, towards the rear of the vehicle.
- (4) A semi-trailer that is extendible, or is fitted with sliding axles, must:
- (a) have a securing device that:
 - (i) can securely fix the extendible part or sliding axles to the rest of the vehicle in any position of adjustment provided; and
 - (ii) is located in a position that can prevent accidental or inadvertent release, if the device is mounted on the chassis of the vehicle; and
 - (iii) is fitted with a visible or audible warning system to indicate to a person standing beside the vehicle that the device is not engaged; and
 - (iv) is fitted with a way of preventing loss of air from the air brake supply, if the device uses air from the brake system and fails in a way allowing air to escape; and
 - (v) is held in the applied position by direct mechanical action without the intervention of an electric, hydraulic or pneumatic device; and
 - (b) be built so the adjustable parts of the vehicle remain connected if the securing device fails.

65 Relation between axles in axle group

- (1) The axles in an axle group, except a twinsteer axle group, fitted to a vehicle with a GVM over 4.5 tonnes must relate to each other through a load-sharing suspension system.

(2) In this rule:

load-sharing suspension system means an axle group suspension system that:

- (a) is built to divide the load between the tyres on the group so that no tyre carries a mass over 10% more than the mass that it would carry if the load were divided equally; and
- (b) has effective damping characteristics on all axles of the group.

Division 2 Dimensions

66 Width

- (1) A vehicle must not be over 2.5 metres wide.
- (2) For subrule (1), the width of a vehicle is measured without taking into account any anti-skid device mounted on wheels, central tyre inflation systems, lights, mirrors, reflectors, signalling devices and tyre pressure gauges.

67 Length of single motor vehicles

- (1) A motor vehicle, except an articulated or controlled access bus, must not be over 12.5 metres long.
- (2) A controlled access bus must not be over 14.5 metres long.
- (3) An articulated bus must not be over 18 metres long.

68 Length of single trailers

- (1) On a semi-trailer or a dog trailer:
 - (a) the distance between the point of articulation at the front of the trailer and the rear overhang line must not be over 9.5 metres; and
 - (b) the distance between the point of articulation at the front of the trailer and the rear of the trailer must not be over 12.3 metres.
- (2) A projection forward of the point of articulation at the front of a semi-trailer must be contained within a radius of 1.9 metres from the point of articulation.

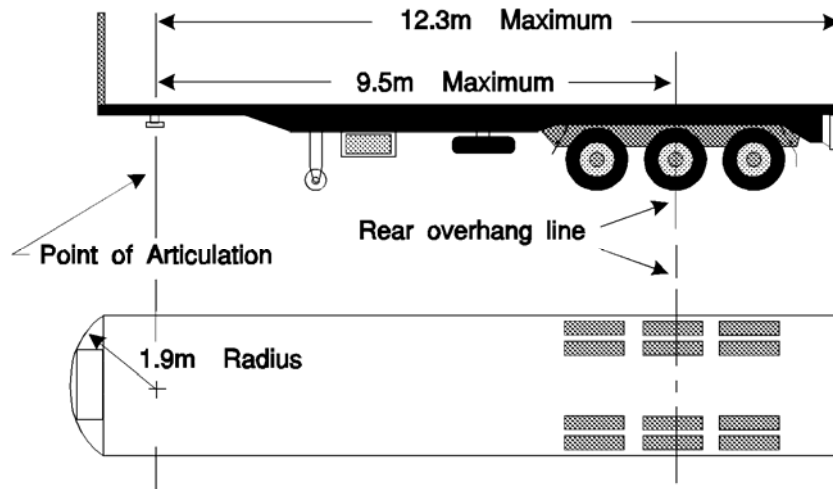

Maximum dimensions of a semi-trailer

- (3) If a semi-trailer has 2 or more points of articulation at the front of the trailer, it must comply with subrules (1) and (2) when measured at one of the points.
- (4) A trailer built to carry cattle, sheep, pigs or horses on 2 or more partly or completely overlapping decks must not have over 12.5 metres of its length available for the carriage of animals.
- (5) For subrule (4), the length available for the carriage of animals on a trailer is measured from the inside of the front wall or door of the trailer to the inside of the rear wall or door of the trailer, with any intervening partitions disregarded.

69 Length of combinations

- (1) A combination must not be over:
 - (a) for a B-double — 25 metres long; and
 - (b) for a road train — 53.5 metres long; and
 - (c) for a combination, except a road train, designed to carry vehicles on 2 or more partly or completely overlapping decks — 25 metres long; and

- (d) for another combination — 19 metres long.
- (2) In a B-double built to carry cattle, sheep, pigs or horses, the 2 semi-trailers must not have over 18.8 metres of their combined length available for the carriage of animals.
- (3) For subrule (2), the length available for the carriage of animals on a trailer is measured from the inside of the front wall or door of the trailer to the inside of the rear wall or door of the trailer, with any intervening partitions disregarded.
- (4) However, a B-double may be up to 26 metres long if:
- (a) the distance between the point of articulation at the front of the leading semi-trailer and the rear of the combination does not exceed 20.6 metres; and
 - (b) the prime mover of the combination is fitted with a front underrun protective device that complies with regulation 93 made under the UN ECE Agreement; and
 - (c) if the prime mover has a date of manufacture after 31 December 2005 – it is fitted with a cab that complies with regulation 29 made under that agreement; and
 - (d) the prime mover does not have a load carrying area.
- (5) In subrule (4):
- UN ECE Agreement* means the *Agreement concerning the adoption of uniform technical prescriptions for wheeled vehicles, equipment and parts which can be fitted and/or be used on wheeled vehicles and the conditions for reciprocal recognition of approvals granted on the basis of these prescriptions* done at Geneva on 20 March 1958, as amended and in effect on 13 July 1999.

Rule 69(4) inserted
by Item 3

Rule 69(5) inserted
by Item 3

70 Rear overhang

- (1) The rear overhang of a semi-trailer, or dog trailer consisting of a semi-trailer and converter dolly, must not exceed the lesser of:
- (a) 60% of the distance between the point of articulation at the front and the rear overhang line; and
 - (b) 3.7 metres.

- (2) A semi-trailer with 2 or more points of articulation at the front must comply with subrule (1) when measured at the same point used for measurement for compliance with rule 68 (3).
- (3) The rear overhang of a trailer with only 1 axle group or single axle (except a semi-trailer) must not exceed the lesser of:
 - (a) the length of the load carrying area, or body, ahead of the rear overhang line; and
 - (b) 3.7 metres.
- (4) The rear overhang of a vehicle not mentioned in subrule (1) or (3) must not exceed the lesser of:
 - (a) 60% of the distance between the centre of the front axle and the rear overhang line; and
 - (b) 3.7 metres.

71 Trailer drawbar length

- (1) The distance between the coupling pivot point on the drawbar of a dog trailer, and the centre line of the front axle group or of the front single axle of the trailer, must:
 - (a) not be over 5 metres; and
 - (b) not be under 3 metres, if the trailer is used in a road train over 19 metres long.

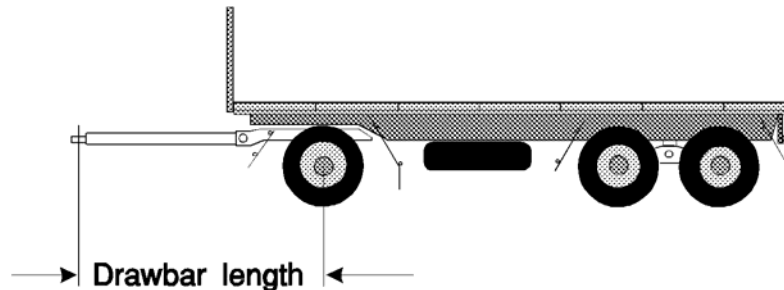

Length of a drawbar on a dog trailer

- (2) The distance between the coupling pivot point on a drawbar, and the centre line of the axle group or single axle on a trailer

with only 1 axle group or single axle (except a semi-trailer) must not be over 8.5 metres.

72 Height

- (1) A vehicle must not be over 4.3 metres high.
- (2) However:
 - (a) a vehicle built to carry cattle, sheep, pigs or horses must not be over 4.6 metres high; and
 - (b) a double-deck bus must not be over 4.4 metres high.

73 Ground clearance

- (1) In this rule:

ground clearance, of a vehicle, means the minimum distance to the ground from a point on the underside of the vehicle, except a point on a tyre, wheel, wheel hub, brake backing plate or flexible mudguard or mudflap of the vehicle.
- (2) A motor vehicle or combination must have a ground clearance of:
 - (a) at least 100 millimetres at any point within 1 metre of an axle; and
 - (b) at least one-thirtieth of the distance between the centres of adjacent axles at the midpoint between them; and
 - (c) at any other point — at least the distance that allows the vehicle or combination to pass over a peak in the road with a gradient on either side of 1:15, if the wheels of 1 axle of the vehicle or combination are on the slope on one side of the peak and the wheels of the next axle are on the slope on the other side.
- (3) However, subrule (2) does not apply to:
 - (a) a motor vehicle with less than 4 wheels; or
 - (b) a combination that includes a motor vehicle with less than 4 wheels.

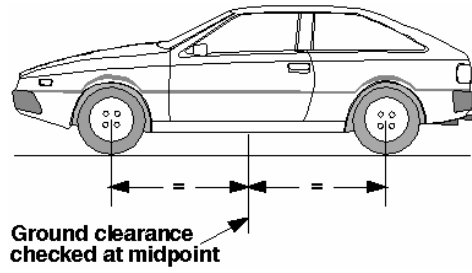

Ground clearance at the mid-point between 2 axles

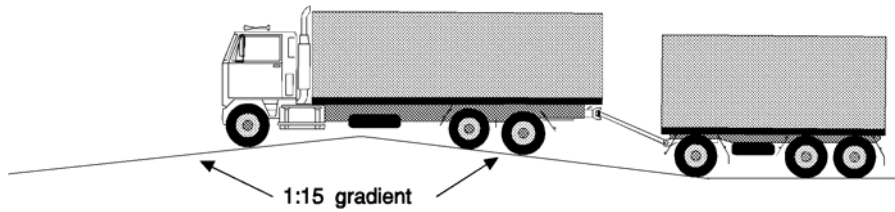

Ground clearance over a peak in the road

Part 8 Lights and reflectors

Note This Part deals with how the lights on a vehicle must be fitted and work so that the driver can see the road, pedestrians and other vehicles at night, and can signal to others.

Other laws provide for when certain lights must be switched on.

In this Part, the description 'yellow' is used as a more modern term, instead of the description 'amber' which is used in earlier legislation and some ADRs.

Division 1 General requirements for lights

74 Certain requirements apply only at night

The requirements of this Part for a light, except a brake or direction indicator light, to be visible over a stated distance apply only at night.

75 Prevention of glare

A light, except a high-beam headlight, fitted to a vehicle must be built and adjusted to provide the necessary amount of light, without dazzling the driver of another vehicle approaching, or being approached by, the vehicle.

76 Pairs of lights

- (1) If lights are required under the Vehicle Standards to be fitted to a vehicle in pairs:
 - (a) a light must be fitted on each side of the longitudinal axis of the vehicle; and
 - (b) the centre of each light in a pair must be the same distance from the longitudinal axis of the vehicle; and

- (c) the centre of each light in a pair must be at the same height above ground level; and
 - (d) each light in a pair must project approximately the same amount of light of the same colour.
- (2) Subrule (1) applies to a motor bike with an attached sidecar as if the sidecar were not attached.

Division 2 Headlights

77 Headlights to be fitted to vehicles

- (1) A motor vehicle must be fitted with:
 - (a) 1 low-beam headlight if it is a moped, motor bike, or motor trike with 1 front wheel; or
 - (b) a pair of low-beam headlights if it has 4 or more wheels or is a motor trike, except a moped, with 2 front wheels.
- (2) If a motor vehicle built after 1934 can travel at over 60 kilometres an hour:
 - (a) each low-beam headlight mentioned in subrule (1) must be able to work in the high-beam position; or
 - (b) the vehicle must be fitted with:
 - (i) 1 headlight that can work in the high-beam position if the vehicle is required to have 1 low-beam headlight; or
 - (ii) a pair of headlights that can work in the high-beam position.
- (3) A motor bike may be equipped with a headlight modulation system that:
 - (a) varies the brightness of its high-beam headlight or low-beam headlight, but not both, at a rate of at least 200 and at most 280 flashes a minute; and
 - (b) is designed to operate only in the daylight.
- (4) Additional headlights may be fitted to a motor bike or motor trike, or a motor vehicle with 4 or more wheels that was built before 1970.
- (5) Additional pairs of headlights may be fitted to a motor vehicle with 4 or more wheels that was built after 1969.

78 How headlights are to be fitted

- (1) The centres of low-beam headlights fitted as a pair on a motor vehicle with 4 or more wheels must be at least 600 millimetres apart.
- (2) However, subrule (1) does not apply to a motor vehicle built before 1970 if the centres of its low-beam headlights:
 - (a) were under 600 millimetres apart when the vehicle was built; and
 - (b) are not nearer than they were when the vehicle was built.
- (3) Each low-beam headlight of a pair on a motor trike (except a moped) with 2 front wheels must not be over 400 millimetres from the nearer side of the vehicle.
- (4) The centre of a low-beam headlight fitted to a motor vehicle built after June 1953 must be:
 - (a) at least 500 millimetres above ground level; and
 - (b) not over 1.4 metres above ground level.

79 How single headlights are to be fitted

- (1) A motor bike or trike with a single headlight fitted must have the light fitted in the centre.
- (2) Subrule (1) applies to a motor bike with an attached sidecar as if the sidecar were not attached.

80 How additional headlights are to be fitted

If 2 or more additional headlights are fitted to a motor vehicle with 4 or more wheels, the additional headlights must as far as possible be fitted in pairs.

81 Performance of headlights

- (1) When on, a headlight, or additional headlight, fitted to a vehicle must:
 - (a) show only white light; and

- (b) project its main beam of light ahead of the vehicle.
- (2) Headlights must be fitted to a vehicle so their light does not reflect off the vehicle into the driver's eyes.

82 Effective range of headlights

- (1) This rule applies to a headlight that is on at night.
- (2) A low-beam headlight must illuminate the road ahead of the vehicle for at least 25 metres.
- (3) A high-beam headlight must illuminate the road ahead of the vehicle for at least 50 metres.
- (4) However, a low-beam headlight fitted to a motor vehicle built before 1931, or a moped, need only illuminate the road ahead of the vehicle for 12 metres.

83 Changing headlights from high-beam to low-beam position

- (1) A motor vehicle built after 1934 that can travel at over 60 kilometres an hour must be fitted with:
 - (a) a dipping device enabling the driver in the normal driving position:
 - (i) to change the headlights from the high-beam position to the low-beam position; or
 - (ii) simultaneously to switch off a high-beam headlight and switch on a low-beam headlight; and
 - (b) for a vehicle built after June 1953 — a device to indicate to the driver that the headlights are in the high-beam position.
- (2) A headlight fitted to a vehicle not fitted with a dipping device mentioned in subrule (1) (a) must operate in the low-beam position.
- (3) When a headlight fitted to a vehicle is switched to the low-beam position, any other headlight on the vehicle must operate only in the low-beam position or be off.

Division 3 Parking lights

84 Parking lights

- (1) A motor vehicle built after June 1953 must be fitted with:
 - (a) a pair of parking lights if it is a motor trike with 2 front wheels (except a moped) or a motor vehicle with 4 or more wheels; or
 - (b) at least 1 parking light if it is a motor bike with an attached sidecar, or a motor trike with 1 front wheel, (except a moped).
- (2) A pair of parking lights fitted to a motor vehicle with 4 or more wheels must be fitted with the centre of each light:
 - (a) at least 600 millimetres from the centre of the other light; and
 - (b) not over 510 millimetres from the nearer side of the vehicle.
- (3) However, a pair of parking lights fitted to a motor vehicle under 1300 millimetres wide may be fitted with the centre of each light not under 400 millimetres from the centre of the other light.
- (4) A parking light fitted to a motor trike with 2 front wheels must not be over 400 millimetres from the nearer side of the vehicle.
- (5) A parking light fitted to a motor bike with a sidecar must be fitted not over 150 millimetres from the side of the sidecar furthest from the motor bike.

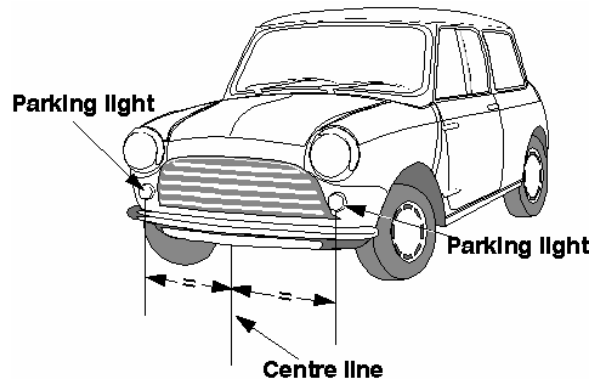

Location of parking lights on a vehicle

- (6) When on, a parking light must:
 - (a) show a white or yellow light visible 200 metres from the front of the vehicle; and
 - (b) not use over 7 watts power.
- (7) A parking light fitted to a motor vehicle built after 1969 must be wired so the parking light is on when a headlight on the vehicle is on.
- (8) A parking light fitted to a sidecar attached to a motor bike must be wired to operate when a headlight, tail light or parking light on the motor bike is on.
- (9) For subrule (3), the width of a vehicle is measured disregarding any anti-skid device mounted on wheels, central tyre inflation systems, lights, mirrors, reflectors, signalling devices and tyre pressure gauges.

Division 4 Daytime running lights

85 Daytime running lights

- (1) A pair of daytime running lights may be fitted to a motor vehicle.
- (2) A pair of daytime running lights fitted to a vehicle with 4 or more wheels must be fitted with the centre of each light:
 - (a) at least 600 millimetres from the centre of the other light; and
 - (b) not over 510 millimetres from the nearer side of the vehicle.
- (3) However, a pair of daytime running lights fitted to a motor vehicle under 1300 millimetres wide may be fitted with the centre of each light not under 400 millimetres from the centre of the other light.

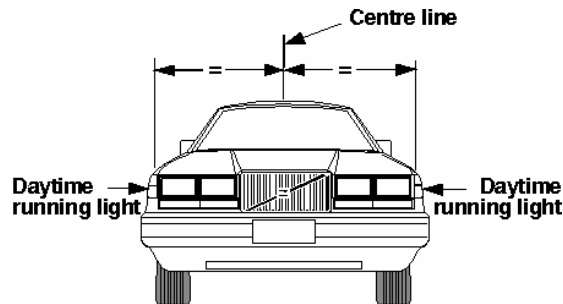

Location of daytime running lights on a vehicle

- (4) When on, a daytime running light must:
 - (a) show a white or yellow light visible from the front of the vehicle; and
 - (b) not use over 25 watts power.

Note The third edition ADRs only allow white daytime running lights.

- (5) Daytime running lights must be wired so they are off when a headlight, except a headlight being used as a flashing signal, is on.
- (6) For subrule (3), the width of a vehicle is measured disregarding any anti-skid device mounted on wheels, central tyre inflation systems, lights, mirrors, reflectors, signalling devices and tyre pressure gauges.

Division 5 Tail lights

86 Tail lights generally

- (1) A vehicle must have at least 1 tail light fitted on or towards the rear of the vehicle.
- (2) A motor trike with 2 rear wheels, or a motor vehicle with 4 or more wheels, built after 1959 must have at least 1 tail light fitted on or towards each side of the rear of the vehicle.
- (3) A trailer built after June 1973 must have at least 1 tail light fitted on or towards each side of the rear of the vehicle.
- (4) The centre of a tail light mentioned in subrule (1), (2) or (3) must not be over:
 - (a) 1.5 metres above ground level; or
 - (b) if it is not practicable to fit the light lower — 2.1 metres above ground level.
- (5) A vehicle may have 1 or more additional tail lights at any height above ground level.

87 Pattern of fitting tail lights

- (1) If only 1 tail light is fitted to a vehicle, it must be fitted in the centre or to the right of the centre of the vehicle's rear.
- (2) Subrule (1) applies to a motor bike with an attached sidecar as if the sidecar were not attached.
- (3) If 2 or more tail lights are fitted to a vehicle, at least 2 must be fitted as a pair.

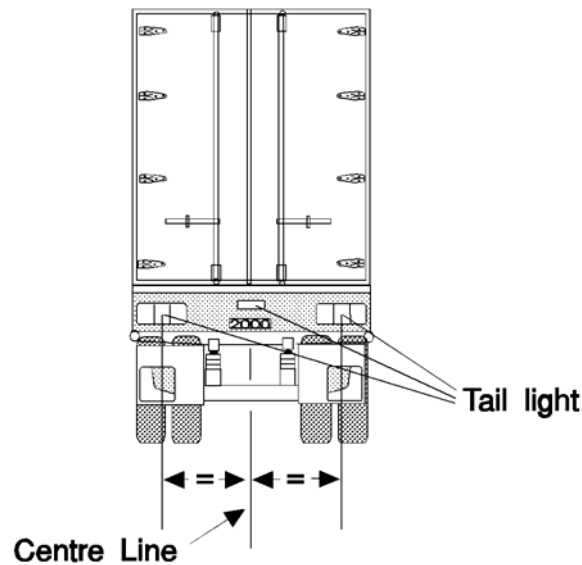

Location of tail lights on a vehicle

- (4) Tail lights fitted in accordance with this Division may also serve as rear clearance lights if they are fitted to a vehicle in accordance with rule 93 (3).

88 Performance of tail lights

- (1) When on, a tail light of a vehicle must:
- (a) show a red light visible 200 metres from the rear of the vehicle; and
 - (b) not use over 7 watts power.
- (2) A tail light fitted to a street rod vehicle may incorporate a blue lens not over 20 millimetres in diameter.
- (3) A **street rod vehicle** is a vehicle that has been modified for safe road use and that:
- (a) has a body and frame that were built before 1949; or
 - (b) is a replica of a vehicle the body and frame of which were built before 1949.

89 Wiring of tail lights

A tail light of a motor vehicle must be wired to come on, and stay on, when a parking light or headlight on the vehicle is on, unless an external switch is fitted to operate the tail light.

Division 6 Number plate lights

90 Number plate lights

- (1) At least 1 number plate light must be fitted to the rear of a vehicle.
- (2) When on, the number plate light or lights must illuminate a number plate on the rear of the vehicle with white light, so the characters on the number plate can be read at night 20 metres from the rear of the vehicle.
- (3) A number plate light:
 - (a) may be combined with another light; and
 - (b) must not project white light to the rear of the vehicle except by reflection; and
 - (c) must not obscure the characters on the number plate; and
 - (d) must be wired to come on, and stay on, when a parking light, headlight or tail light on the vehicle is on.

Division 7 Clearance lights

91 Front clearance lights

- (1) Front clearance lights may only be fitted to a vehicle that is at least 1.8 metres wide.
- (2) A pair of front clearance lights must be fitted to a motor vehicle that is at least 2.2 metres wide, or a prime mover.
- (3) The centre of a front clearance light must be:
 - (a) not over 400 millimetres from the nearer side of the vehicle; and
 - (b) if the vehicle was built after June 1953:
 - (i) at least 750 millimetres higher than the centre of any low-beam headlight fitted to the vehicle; or
 - (ii) not lower than the top of the windscreen.
- (4) However, a front clearance light may be mounted on an external rear vision mirror or a mirror support if, when the mirror is correctly adjusted, no part of the lens of the clearance light is visible to a person in the normal driving position.
- (5) When on, a front clearance light must:
 - (a) show a yellow or white light visible 200 metres from the front of the vehicle; and
 - (b) not use over 7 watts power.

92 External cabin lights

- (1) A motor vehicle fitted with front clearance lights may also have additional forward-facing lights on or above the roof of its cabin.
- (2) The additional forward-facing lights must be spaced evenly between the front clearance lights, with their centres at least 120 millimetres apart.

- (3) When on, an additional forward-facing light must:
 - (a) show a yellow or white light; and
 - (b) not use over 7 watts power.

93 Rear clearance lights

- (1) Rear clearance lights may only be fitted to a vehicle that is at least 1.8 metres wide.
- (2) A pair of rear clearance lights must be fitted to the rear of a vehicle that is at least 2.2 metres wide.
- (3) The centre of a rear clearance light must be:
 - (a) not over 400 millimetres from the nearer side of the vehicle; and
 - (b) if practicable, at least 600 millimetres above ground level.
- (4) When on, a rear clearance light must:
 - (a) show a red light visible 200 metres from the rear of the vehicle; and
 - (b) not use over 7 watts power.

Division 8 Side marker lights

94 Vehicles needing side marker lights

- (1) A pair of side marker lights must be fitted towards the rear of the sides of a motor vehicle that is over 7.5 metres long and at least 2.2 metres wide.
- (2) A pole-type trailer, and a motor vehicle built to tow a pole-type trailer, with at least 1 cross-bar or bolster must have a side marker light fitted to each side of the back or only cross-bar or bolster.
- (3) A pole-type trailer with 2 or more cross-bars or bolsters may also have a side marker light fitted to each side of the front cross-bar or bolster.
- (4) At least 2 side marker lights must be fitted to each side of:
 - (a) a trailer, except a pole-type trailer, that is at least 2.2 metres wide and not over 7.5 metres long; and
 - (b) a semi-trailer that is not over 7.5 metres long.
- (5) At least 3 side marker lights must be fitted to each side of:
 - (a) a trailer, except a pole-type trailer, that is at least 2.2 metres wide and over 7.5 metres long; and
 - (b) a semi-trailer that is over 7.5 metres long.
- (6) For subrules (1), (4) and (5), the width of a vehicle is measured disregarding any anti-skid device mounted on wheels, central tyre inflation systems, lights, mirrors, reflectors, signalling devices and tyre pressure gauges.

95 Location of side marker lights

- (1) The centre of a side marker light must not be over 150 millimetres from the nearer side of the vehicle.
- (2) A front side marker light fitted to a motor vehicle must be towards the front of the side of the vehicle with no part of the lens visible to the driver.

- (3) The centre of a front side marker light fitted to a trailer must be:
 - (a) within 300 millimetres of the front of the side of the trailer; or
 - (b) if the construction of the trailer makes it impracticable to comply with paragraph (a) — as near as practicable to the front of the trailer.
- (4) The centre of a rear side marker light fitted to a vehicle must be:
 - (a) within 300 millimetres of the rear of the side of the vehicle; or
 - (b) if the construction of the vehicle makes it impracticable to comply with paragraph (a) — as near as practicable to the rear of the vehicle.
- (5) Side marker lights fitted to a vehicle must, as far as practicable, be evenly spaced along the side of the vehicle.
- (6) Subrules (2) to (5) do not apply to side marker lights fitted to a cross-bar or bolster of a pole-type trailer.
- (7) Only the side marker lights nearest to the rear need be fitted if complying with subrules (3) and (4) would result in the front and rear side marker lights being under 2.5 metres apart.
- (8) A side marker light fitted to a vehicle must be fitted so:
 - (a) its centre is not over:
 - (i) 1.5 metres above ground level; or
 - (ii) if it is not practicable to fit it lower — 2.1 metres above ground level; and
 - (b) its centre is at least 600 millimetres above ground level; and
 - (c) it is, as far as practicable, in a row of side marker lights along the side of the vehicle.
- (9) Subrule (8) (a) does not apply to a side marker light that is not required to be fitted to the vehicle by rule 94.

96 Performance of side marker lights

- (1) When on, a side marker light fitted to a vehicle must:
 - (a) show a light visible 200 metres from the vehicle; and
 - (b) not use over 7 watts power.
- (2) When on, a side marker light fitted to a vehicle must show:
 - (a) to the front of the vehicle — a yellow light; and
 - (b) to the rear of the vehicle:
 - (i) if the light also operates as a rear light or reflector — a red light; and
 - (ii) in any other case — a red or yellow light.
- (3) However, if a pole-type trailer with 2 or more cross-bars or bolsters has the side marker lights permitted by rule 94 (3):
 - (a) the side marker lights fitted to the front cross-bar or bolster may comply with subrule (2) (a) only; and
 - (b) the side marker lights fitted to the back cross-bar or bolster may comply with subrule (2) (b) only.

97 Side marker lights and rear clearance lights

The side marker light nearest to the rear of a vehicle may also be a rear clearance light for rule 93.

Division 9 Brake lights

98 Fitting brake lights

- (1) A brake light must be fitted to the rear of a vehicle built after 1934.
- (2) A pair of brake lights must be fitted to the rear of:
 - (a) a motor vehicle built after 1959 that has 4 or more wheels; and
 - (b) a motor trike built after 1959 that has 2 rear wheels; and
 - (c) a trailer built after June 1973.
- (3) The centre of a brake light must be:
 - (a) at least 350 millimetres above ground level; and
 - (b) not over:
 - (i) 1.5 metres above ground level; or
 - (ii) if it is not practicable to fit the light lower — 2.1 metres above ground level.
- (4) A vehicle may be fitted with 1 or more additional brake lights.
- (5) The centre of an additional brake light must be at least 350 millimetres above ground level.
- (6) If only 1 brake light is fitted to a vehicle, it must be fitted in the centre or to the right of the centre of the vehicle's rear.
- (7) Subrule (6) applies to a motor bike with an attached sidecar as if the sidecar were not attached.

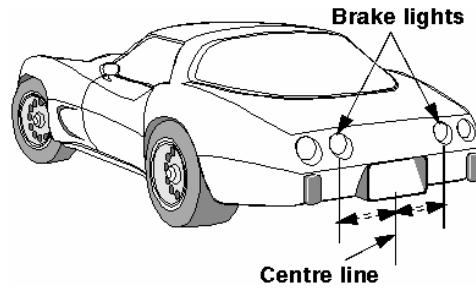

Location of brake lights on a vehicle

99 Performance and operation of brake lights

- (1) When on, a brake light must show a red light visible 30 metres from the rear of the vehicle.
- (2) A brake light fitted to a street rod vehicle may incorporate a blue lens not over 20 millimetres in diameter.
- (3) A brake light fitted to a motor vehicle must come on, if it is not already on, when:
 - (a) for a vehicle with 4 or more wheels or built after 1974 — a service brake is applied; or
 - (b) for another vehicle — the rear wheel brake is applied.
- (4) Subrule (3) does not apply if the controls in the vehicle that start the engine are in a position that makes it impossible for the engine to operate.
- (5) A brake light on a trailer must come on when:
 - (a) the brake light of the towing vehicle comes on; or
 - (b) a brake control on the towing vehicle, which independently activates the service brake on the trailer, is operated.
- (6) A brake light may be operated by an engine brake, retarder, or similar device if the device does not interfere with the proper operation of the brake light.

- (7) A ***street rod vehicle*** is a vehicle that has been modified for safe road use and that:
- (a) has a body and frame that were built before 1949; or
 - (b) is a replica of a vehicle the body and frame of which were built before 1949.

Division 10 Reversing lights

100 Reversing lights

- (1) One or more reversing lights may be fitted to the rear of a vehicle and on each side towards the rear of the vehicle.
- (2) A reversing light must have its centre not over 1.2 metres above ground level.
- (3) When on, a reversing light must show a white or yellow light to the rear or to the side and rear of the vehicle.

Note Third edition ADRs only allow white reversing lights.

- (4) A reversing light fitted to a motor vehicle must be wired so it operates only when the vehicle is reversing or in reverse gear.
- (5) A reversing light fitted to a trailer must be wired so it operates only when a motor vehicle towing the trailer is reversing or in reverse gear.
- (6) A yellow reversing light may also operate as a direction indicator light.

Division 11 Direction indicator lights

101 Direction indicator lights on motor vehicles

- (1) A motor vehicle with 4 or more wheels that was built after August 1966 must have:
 - (a) a pair of direction indicator lights fitted on, or towards, its front that face forwards; and
 - (b) a pair of direction indicator lights fitted on, or towards, its rear that face backwards.
- (2) A motor vehicle with less than 4 wheels that was built after June 1975 must have:
 - (a) a pair of direction indicator lights fitted on, or towards, its front that face forwards; and
 - (b) a pair of direction indicator lights fitted on, or towards, its rear that face backwards.
- (3) A motor vehicle that is not required to have direction indicator lights may have:
 - (a) 1 or more pairs of direction indicator lights that are visible from both the front and rear of the vehicle; or
 - (b) both:
 - (i) a pair of direction indicator lights fitted on, or towards, its front that face forwards; and
 - (ii) a pair of direction indicator lights fitted on, or towards, its rear that face backwards.

102 Direction indicator lights on trailers

- (1) A trailer built after June 1973 must have a pair of direction indicator lights fitted on, or towards, its rear that face backwards.
- (2) A trailer that is not required to have direction indicator lights may have 1 or more pairs of direction indicator lights fitted on, or towards, its rear that face backwards.

103 Location of direction indicator lights

- (1) A pair of direction indicator lights fitted to a vehicle must have the centre of each light at least:
 - (a) for a motor bike or the single wheel end of a motor trike — 300 millimetres from the centre of the other light; and
 - (b) for lights fitted at the 2 wheel end of a motor trike — 600 millimetres from the centre of the other light, unless the centre of each direction indicator light is not over 400 millimetres from the nearer side of the vehicle; and
 - (c) for another vehicle with a width of not over 1300 millimetres — 400 millimetres from the centre of the other light; and
 - (d) for another vehicle with a width of over 1300 millimetres — 600 millimetres from the centre of the other light.
- (2) The centre of each direction indicator light must be at least 350 millimetres above ground level.
- (3) The centre of each light in a pair of direction indicator lights required to be fitted to a vehicle must not be over:
 - (a) 1.5 metres above ground level; or
 - (b) if it is not practicable for the light to be fitted lower — 2.1 metres above ground level.
- (4) For subrule (1), the width of a vehicle is measured disregarding any anti-skid device mounted on wheels, central tyre inflation systems, lights, mirrors, reflectors, signalling devices and tyre pressure gauges.

104 Operation and visibility of direction indicator lights

- (1) A direction indicator light fitted to a motor vehicle must:
 - (a) when operating, display regular flashes of light at a rate of not over 120, and:
 - (i) for a motor vehicle with 4 or more wheels — at least 60, flashes a minute; and
 - (ii) for another motor vehicle — at least 45, flashes a minute; and

- (b) be able to be operated by a person in the normal driving position; and
 - (c) be wired to an audible or visible device in the vehicle that tells the driver that the direction indicator light is operating; and
 - (d) flash at the same time and rate as any other direction indicator lights fitted on the same side of the vehicle.
- (2) A direction indicator light fitted to a side of a trailer must, when operating, flash at the same time and rate as the direction indicator light or lights fitted to the same side of the motor vehicle towing the trailer.
- (3) The flashes of light displayed by a direction indicator light must be:
- (a) if the light faces forwards — white or yellow; and
 - (b) if the light faces backwards:
 - (i) yellow; or
 - (ii) for a vehicle built before July 1973 — yellow or red; and
 - (c) if the light faces out from the side of the vehicle:
 - (i) white or yellow towards the front and side; and
 - (ii) for a vehicle built before July 1973 — yellow or red towards the rear and side; and
 - (iii) for a vehicle built after June 1973 — yellow towards the rear and side.
- Note* The ADRs only allow yellow direction indicator lights.
- (4) If a motor vehicle's direction indicator lights display only yellow light, the vehicle may be equipped to allow the lights to operate simultaneously on both sides of the vehicle, if a visible or audible signal tells the driver when the lights are operating simultaneously.
- (5) When on, a direction indicator light must be visible 30 metres from:
- (a) if the light faces forwards — the front of the vehicle; or
 - (b) if the light faces backwards — the rear of the vehicle; or

- (c) if the light faces out from the side of the vehicle — that side of the vehicle.
- (6) When on, each direction indicator light in at least 1 pair of lights fitted on or towards the front of a prime mover, or a motor vehicle over 7.5 metres long, must be visible at a point:
 - (a) 1.5 metres at right angles from the side of the vehicle where the light is fitted; and
 - (b) in line with the rear of the vehicle.

Division 12 Fog lights

105 Front fog lights

- (1) A pair of front fog lights may be fitted to a motor vehicle with 4 or more wheels.
- (2) A pair of front fog lights, or a single front fog light, may be fitted to a motor bike or trike.
- (3) A pair of front fog lights fitted to a motor vehicle with 4 or more wheels must have the centre of each light not over 400 millimetres from the nearer side of the vehicle unless the centres of the lights are at least 600 millimetres apart.
- (4) If the top of the front fog light is higher than the top of any low-beam headlight on the vehicle, the centre of the fog light must not be higher than the centre of the low-beam headlight.
- (5) A front fog light must:
 - (a) when on:
 - (i) project white or yellow light in front of the vehicle; and
 - (ii) be a low-beam light; and
 - (b) be able to be operated independently of any headlight; and
 - (c) be fitted so the light from it does not reflect off the vehicle into the driver's eyes.

106 Rear fog lights

- (1) A vehicle may have fitted to its rear:
 - (a) a pair of rear fog lights; or
 - (b) 1 rear fog light fitted on, or to the right, of the centre of the vehicle.
- (2) Subrule (1) (b) applies to a motor bike with an attached sidecar as if the sidecar were not attached.

- (3) A rear fog light must:
- (a) have its centre:
 - (i) not over 1.5 metres above ground level; and
 - (ii) at least 100 millimetres from the centre of a brake light; and
 - (b) when on, project red light behind the vehicle; and
 - (c) not use over 27 watts power; and
 - (d) be wired to a visible device in the vehicle that tells the driver that the rear fog light is operating.

Division 13 Interior lights

107 Interior lights

A vehicle may be fitted with interior lights that illuminate any interior part of the vehicle.

Division 14 Reflectors generally

108 General requirements for reflectors

- (1) A reflector fitted to a vehicle must show a red, yellow or white reflection of light when light is projected directly onto the reflector at night by a low-beam headlight that:
 - (a) is 45 metres from the reflector; and
 - (b) complies with the Vehicle Standards.
- (2) The reflection must be clearly visible from the position of the headlight.

Division 15 Rear reflectors

109 Rear reflectors

- (1) A motor vehicle with 4 or more wheels, and a trailer, must have a rear-facing red reflector towards each side of its rear.
- (2) A motor bike, a sidecar attached to a motor bike, and a motor trike, must have a rear-facing red reflector.
- (3) The centre of each reflector must be:
 - (a) at the same height above ground level; and
 - (b) not over 1.5 metres above ground level.
- (4) However, subrule (3) does not apply to a reflector fitted to a sidecar attached to a motor bike.
- (5) A reflector fitted to a motor vehicle with 4 or more wheels, or a trailer, must not be over 400 millimetres from the nearer side of the vehicle.
- (6) A vehicle fitted with rear-facing red reflectors in accordance with subrule (1) or (2) may be fitted with additional red reflectors at any height above ground level or at any distance from the side of the vehicle.

Division 16 Side reflectors

110 Compulsory side reflectors on pole-type trailers

- (1) Yellow or red side-facing reflectors must be fitted to the pole of a pole-type trailer so:
 - (a) 1 reflector is fitted to the middle third of the left and right faces of the pole; and
 - (b) the front reflector is not over 3 metres from the front of the trailer; and
 - (c) the other reflectors are not over 3 metres apart.
- (2) Additional side-facing reflectors may be fitted to a pole-type trailer in accordance with rule 111.

111 Optional side reflectors

- (1) A vehicle may be fitted with side-facing reflectors.
- (2) A side-facing reflector:
 - (a) towards the front of the vehicle must be yellow or white; and
 - (b) towards the rear of the vehicle must be yellow or red; and
 - (c) on the central part of the vehicle must be yellow.

Division 17 Front reflectors

112 Compulsory front reflectors on trailers

- (1) A front-facing white or yellow reflector must be fitted towards each side of the front of:
 - (a) a semi-trailer, except a pole-type trailer; and
 - (b) the front cross-bar or bolster of a pole-type trailer; and
 - (c) a trailer that is at least 2.2 metres wide.
- (2) Each reflector must have its centre:
 - (a) at the same height above ground level; and
 - (b) not over 1.5 metres above ground level; and
 - (c) not over 400 millimetres from the nearer side of the vehicle.
- (3) Additional front-facing reflectors may be fitted to a trailer mentioned in subrule (1) in accordance with rule 113.

113 Optional front reflectors

- (1) A motor vehicle with 4 or more wheels, or a trailer, may have 1 or more front-facing white or yellow reflectors fitted towards each side of its front.
- (2) A motor vehicle with less than 4 wheels may have 1 or more front-facing white or yellow reflectors.
- (3) The centre of at least 1 reflector on each side of the front of the vehicle must be:
 - (a) at the same height above ground level as the centre of the other reflector; and
 - (b) the same distance from the longitudinal axis of the vehicle as the centre of the other reflector; and

- (c) at least:
 - (i) for a vehicle with a width under 1300 millimetres — 400 millimetres from the centre of the other reflector; and
 - (ii) for another vehicle — 600 millimetres from the centre of the other reflector.
- (4) For subrule (3)(c), the width of a vehicle is measured disregarding any anti-skid device mounted on wheels, central tyre inflation systems, lights, mirrors, reflectors, signalling devices and tyre pressure gauges.

Division 18 Warning lights and signs on buses carrying children

114 Application of Division

This Division applies to a bus that is used mainly for carrying children if the bus is fitted with warning lights after June 1999.

Note For warning signs and lights fitted before July 1999, see rule 118.

115 Fitting of warning lights and signs

- (1) Two warning lights and a warning sign must be fitted to the front and rear of the bus.
- (2) The warning lights must be fitted:
 - (a) on each side of, and the same distance from, the centre of the warning sign; and
 - (b) with the edge of the warning sign not over 100 millimetres from the nearest point on the lens of the warning lights; and
 - (c) with the distance between the warning lights at least 300 millimetres at the nearest point; and
 - (d) so no part of the bus obstructs the light displayed:
 - (i) 30° to the left and right of the centre of each light; and
 - (ii) 10° above and below the centre of each light.
- (3) The warning lights may be on the warning sign if the words or image on the sign are not obscured.
- (4) The warning lights at the same end of the bus must be fitted:
 - (a) at the same height; and
 - (b) as high as practicable; and
 - (c) with the lowest point on the lens of each light not lower than midway between the highest and lowest points on the bus body.

- (5) If the centres of the warning lights are under 1.8 metres above ground level, no part of the warning lights or warning sign may be on the left of the bus.
- (6) This rule applies to a bus despite any requirement of a third edition ADR.

116 Operation and performance of warning lights

- (1) When operating, a warning light must display regular flashes of yellow light at a rate of at least 90, and not over 180, flashes a minute.
- (2) The warning lights at the same end of the bus must flash alternately.
- (3) Unless the driver has turned the warning lights off, they must operate automatically when a door on the bus opens and for at least 10, and not over 20, seconds after all the doors on the bus have closed.
- (4) The bus must have a visible or audible signal that tells the driver when the warning lights are operating.
- (5) The bus must be fitted with a switch that allows the driver to turn the warning lights off.
- (6) A warning light must have:
 - (a) an effective lit lens area of at least 60 square centimetres; and

- (b) a luminous intensity (in candela) of at least the values mentioned in the following table when measured at the angles mentioned in the table.

Vertical angle from centre of light	Horizontal angle from centre of light								
	-30°	-20°	-10°	-5°	0°	5°	10°	20°	30°
10°				50	80	50			
5°		180	320	350	450	350	320	180	
0°	75	450	1000	1250	1500	1250	1000	450	75
-5°	40	270	450	570	600	570	450	270	40
-10°				75	75	75			

- (7) For subrule (6) (b), the luminous intensity of a light is to be measured in accordance with the test method mentioned in third edition ADR 6.

117 Specifications for warning signs

- (1) A warning sign at the front of the bus must:
- display the words 'school bus' in capital letters at least 100 millimetres high; or
 - display an image of 2 children in the same proportions as the children in AS 1743 *Road Signs — Specifications* (image W6-3), with the image of the taller child at least 230 millimetres high.
- (2) A warning sign at the rear of the bus must display an image of 2 children in the same proportions as the children in AS 1743 *Road Signs — Specifications* (image W6-3), with the image of the taller child at least 230 millimetres high.
- (3) The warning sign mentioned in subrules (1) (b) and (2) must:
- be a rectangular shape at least:
 - if warning lights are on the warning sign — 550 millimetres wide and 400 millimetres high; and

- (ii) in any other case — 400 millimetres wide and 250 millimetres high; and
- (b) have a black border; and
- (c) have black graphics and be coated with yellow retro-reflective material of class 1 or 2 that meets Australian Standard AS 1906 *Retro-reflective Materials and Devices for Road Traffic Control Purposes*.

Division 19 Other lights, reflectors, rear marking plates or signals

118 Other lights and reflectors

(1) In this rule:

exempt vehicle means:

- (a) a police vehicle; or
- (b) an emergency vehicle; or
- (c) a transport enforcement vehicle; or
- (d) an Australian Protective Service vehicle; or
- (e) an Australian Customs Service vehicle; or
- (f) an Airservices Australia vehicle.

special use vehicle means:

- (a) a vehicle built or fitted for use in hazardous situations on a road; or
- (b) a vehicle, or combination, that because of its dimensions is permitted to be driven on a road only in accordance with a notice or permit issued under a law of this jurisdiction; or
- (c) a vehicle built or fitted to accompany a vehicle, or combination, mentioned in paragraph (b); or
- (d) a bus fitted, before July 1999, with a sign telling road users that the bus carries children.

Examples of special use vehicles to which paragraph (a) applies

- 1. Tow trucks.
- 2. Vehicle breakdown service vehicles.

(2) A vehicle may be fitted with a light or reflector not mentioned in the Vehicle Standards only if another law of this jurisdiction allows that light or reflector to be fitted.

Rule 118(2)
substituted by
Item 4

(3) However, unless subrule (4) applies, a vehicle must not be fitted with:

Rule 118(3)
amended by Item
4

- (a) a light that flashes; or

- (b) a light or reflector that:
 - (i) shows a red light to the front; or
 - (ii) shows a white light to the rear; or
 - (iii) is shaped or located in a way that reduces the effectiveness of a light or reflector that is required to be fitted to the vehicle under the Vehicle Standards.
- (4) Despite any requirement of a third edition ADR, an exempt vehicle may be fitted with any light or reflector, and a special use vehicle may be fitted with 1 or more flashing yellow lights.

119 Rear marking plates

- (1) In this rule:
rear marking plate means a rear marking plate complying with Vehicle Standards Bulletin VSB 12.
- (2) Rear marking plates must be fitted to:
 - (a) a motor vehicle with a GVM over 12 tonnes, except a bus fitted with hand grips or similar equipment for standing passengers to hold; and
 - (b) a trailer with a GTM over 10 tonnes.
- (3) Subrule (2) applies to a vehicle even if it was built before the date stated in the VSB.
- (4) Rear marking plates may be fitted to a motor vehicle with a GVM not over 12 tonnes or a trailer with a GTM not over 10 tonnes.

Rule 119(1)
amended by Item
4

Rule 119(3)
amended by Item
4

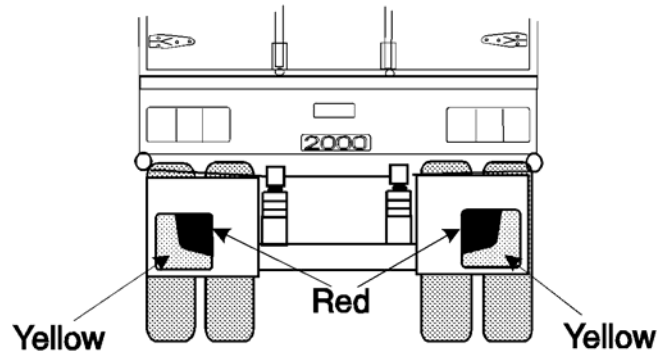

An example of rear marking plates

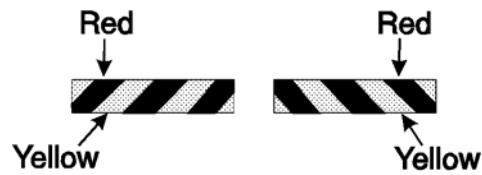

An alternative pattern for rear marking plates

120 Signalling devices

- (1) This rule applies to a motor vehicle if:
 - (a) the vehicle is not fitted with a brake light or direction indicator light mentioned in Division 9 or 11; and
 - (b) the construction of the vehicle would otherwise prevent the driver from hand signalling an intention:
 - (i) to turn or move the vehicle to the right; or
 - (ii) to stop or suddenly reduce the speed of the vehicle.
- (2) The vehicle must be fitted with a mechanical signalling device or a pair of turn signals.

121 Mechanical signalling devices

- (1) A mechanical signalling device must:
 - (a) be fitted to the right side of the vehicle; and
 - (b) be able to be operated by the driver from a normal driving position; and
 - (c) consist of a white or yellow representation of an open human hand at least 15 centimetres long; and
 - (d) be constructed so that the driver of the vehicle can keep the device:
 - (i) in a neutral position so it is unlikely that the driver of another vehicle or anyone else would regard it as a signal; and
 - (ii) in a horizontal position with the palm of the hand facing forwards and the fingers pointing out at a right angle to the vehicle to signal an intention to turn or move right; and
 - (iii) with the palm of the hand facing forwards and the fingers pointing upwards to signal an intention to stop or reduce speed suddenly.
- (2) When the mechanical signalling device is in a position mentioned in subrule (1) (d) (ii) or (iii), the complete hand must be clearly visible from both the front and the rear of the vehicle, at a distance of 30 metres.

122 Turn signals

A turn signal must:

- (a) consist of a steady or flashing illuminated yellow sign at least 15 centimetres long and 25 millimetres wide that:
 - (i) when in operation — is kept horizontal; and
 - (ii) when not in operation — is kept in a position so it is unlikely that the driver of another vehicle or anyone else would regard it as a signal; and
- (b) be fitted to the side of the motor vehicle at least 50 centimetres and not over 2.1 metres above ground level, in a position so the driver of the vehicle, from the

- normal driving position, can see whether the signal is in operation; and
- (c) be able to be operated by the driver from the normal driving position; and
 - (d) when in operation, be visible from both the front and rear of the vehicle at a distance of 30 metres.

Division 20 Vehicles not required to have lights or reflectors

123 Certain vehicles used in daylight

This Part does not apply to a vehicle built before 1931 that is used only in the daylight.

124 Certain vehicles used for collection or exhibition purposes

This Part does not apply to a vehicle built before 1946 that is used mainly for exhibition purposes.

Part 9 Braking systems

Note This Part sets out the braking system requirements for vehicles to ensure that they can be reliably slowed or stopped even if a part of a braking system fails, and to ensure that a vehicle can be prevented from rolling away when parked.

The Part also includes special requirements for braking systems on B-doubles and road trains to ensure that the braking systems on the component vehicles are compatible. The special requirements do not apply to a road train that is 19 metres long or less.

Division 1 Brake requirements for all vehicles

125 Parts of a braking system

- (1) A brake tube or hose fitted to a vehicle must:
 - (a) be manufactured from a material appropriate to its intended use in the vehicle; and
 - (b) be long enough to allow for the full range of steering and suspension movements of the vehicle; and
 - (c) be fitted to prevent it being damaged during the operation of the vehicle by:
 - (i) a source of heat; or
 - (ii) any movement of the parts to which it is attached or near.
- (2) Each component of the braking system of a vehicle with a GVM over 4.5 tonnes must comply with the design and performance requirements of:
 - (a) a relevant Australian Standard or British Standard as in force when this subrule commenced; or
 - (b) a relevant standard approved by any of the following bodies, and as in force when this subrule commenced:
 - American Society of Automotive Engineers
 - American National Standards Institute
 - Japanese Standards Association
 - Deutsches Institut für Normung

- International Organisation for Standardisation.

126 Provision for wear

The braking system of a vehicle must allow for adjustment to take account of normal wear.

127 Supply of air or vacuum to brakes

- (1) If air brakes are fitted to a vehicle:
 - (a) the compressor supplying air to the brakes must be able to build up air pressure to at least 80% of the governor cut-out pressure in not over 5 minutes after the compressed air reserve is fully used up; and
 - (b) for a vehicle with a GVM over 4.5 tonnes — the air storage tanks must have sufficient capacity to allow 5 applications of the service brakes before the air pressure drops below half the governor cut-out pressure; and
 - (c) there must be an automatic or manual condensate drain valve at the lowest point of each air brake reservoir in the system; and
 - (d) any spring brake fitted to the vehicle must not operate before the warning mentioned in rule 131 (4) (a) or 134 (3) (a) has been given.
- (2) If vacuum brakes are fitted to a vehicle, the vacuum supply must be able to build up vacuum:
 - (a) to the level when the warning signal mentioned in rule 131 (4) (a) or 134 (3) (a) no longer operates within 30 seconds after the vacuum reserve is fully used up; and
 - (b) to the normal working level within 60 seconds after the vacuum reserve is fully used up.

128 Performance of braking systems

- (1) One sustained application of the brake of a motor vehicle built after 1930, or a combination that includes a motor vehicle built after 1930, must be able to produce the performance mentioned in subrules (2) to (7):
 - (a) when the vehicle or combination is on a dry, smooth, level road surface, free from loose material; and
 - (b) whether or not the vehicle or combination is loaded; and
 - (c) without part of the vehicle or combination moving outside a straight path:
 - (i) centred on the longitudinal axis of the vehicle or combination before the brake was applied; and
 - (ii) 3.7 metres wide.
- (2) The braking system of a motor vehicle or combination with a gross mass under 2.5 tonnes must bring the vehicle or combination from a speed of 35 kilometres an hour to a stop within:
 - (a) 12.5 metres when the service brake is applied; and
 - (b) 30 metres when the emergency brake is applied.
- (3) The braking system of a motor vehicle or combination with a gross mass of at least 2.5 tonnes must bring the vehicle or combination from a speed of 35 kilometres an hour to a stop within:
 - (a) 16.5 metres when the service brake is applied; and
 - (b) 40.5 metres when the emergency brake is applied.
- (4) The braking system of a motor vehicle or combination with a gross mass under 2.5 tonnes must decelerate the vehicle or combination, from any speed at which the vehicle or combination can travel, by an average of at least:
 - (a) 3.8 metres a second a second when the service brake is applied; and
 - (b) 1.6 metres a second a second when the emergency brake is applied.

- (5) The braking system of a motor vehicle or combination with a gross mass of at least 2.5 tonnes must decelerate the vehicle or combination, from any speed at which the vehicle or combination can travel, by an average of at least:
 - (a) 2.8 metres a second a second when the service brake is applied; and
 - (b) 1.1 metres a second a second when the emergency brake is applied.
- (6) The braking system of a motor vehicle or combination with a gross mass under 2.5 tonnes must achieve a peak deceleration of the vehicle or combination, from any speed at which the vehicle or combination can travel, of at least:
 - (a) 5.8 metres a second a second when the service brake is applied; and
 - (b) 1.9 metres a second a second when the emergency brake is applied.
- (7) The braking system of a motor vehicle or combination with a gross mass of at least 2.5 tonnes must achieve a peak deceleration of the vehicle or combination, from any speed at which the vehicle or combination can travel, of at least:
 - (a) 4.4 metres a second a second when the service brake is applied; and
 - (b) 1.5 metres a second a second when the emergency brake is applied.
- (8) The parking brake of a vehicle or combination must be able to hold the vehicle or combination stationary on a 12% gradient.

Division 2 Motor vehicle braking systems

129 What braking system a motor vehicle must have

- (1) In this rule:
independent brake, for a vehicle, means a brake that is operated entirely separately from any other brake on the vehicle, except for any drum, disc or part, on which a shoe, band or friction pad makes contact, that is common to 2 or more brakes.
- (2) A motor vehicle with 4 or more wheels built, or used, mainly for transporting goods or people by road must be fitted with:
 - (a) a braking system that:
 - (i) consists of brakes fitted to all wheels of the vehicle; and
 - (ii) has at least 2 separate methods of activation, arranged so effective braking remains on at least 2 wheels if a method fails; or
 - (b) 2 independent brakes, each of which, when in operation, acts directly on at least half the number of wheels of the vehicle.
- (3) The braking system of a motor vehicle mentioned in subrule (2) that was built after 1945 must have a service brake operating on all wheels that, when applied:
 - (a) acts directly on the wheels and not through the vehicle's transmission; or
 - (b) acts on a shaft between a differential of the vehicle and a wheel.
- (4) The braking system of a motor vehicle with 4 or more wheels must have a parking brake that:
 - (a) is held in the applied position by direct mechanical action without the intervention of an electrical, hydraulic or pneumatic device; and
 - (b) is fitted with a locking device that can hold the brake in the applied position; and

- (c) has its own separate control.
- (5) The parking brake may also be the emergency brake.
- (6) If 2 or more independent brakes are fitted to a motor vehicle with 4 or more wheels, the brakes must be arranged so brakes are applied to all the wheels on at least 1 axle of the vehicle when any brake is operated.
- (7) A motor bike or motor trike must be fitted with:
 - (a) 2 independent brakes; or
 - (b) a single brake that acts directly on all wheels of the vehicle and is arranged so effective braking remains on at least 1 wheel if a part of the system fails.
- (8) Subrule (7) applies to a motor bike with a sidecar attached as if the sidecar were not attached.
- (9) A motor trike must have a parking brake that is held in the applied position by mechanical means.

130 Operation of brakes on motor vehicles

The braking system on a motor vehicle must be arranged to allow the driver of the motor vehicle to apply the brakes from a normal driving position.

131 Air or vacuum brakes on motor vehicles

- (1) If a motor vehicle has air brakes, the braking system of the vehicle must include at least 1 air storage tank.
- (2) If a motor vehicle has vacuum brakes, the braking system of the vehicle must include at least 1 vacuum storage tank.
- (3) An air or vacuum storage tank must be built so the service brake can be applied to meet the performance standards of rule 128 at least twice if the engine of the vehicle stops or the source of air or vacuum fails.

- (4) An air or vacuum storage system must:
 - (a) be built to give a visible or audible warning to the driver, while in a normal driving position, of a lack of air or vacuum that would prevent the service brake from being applied to meet the performance standards of rule 128 at least twice; and
 - (b) be safeguarded by a check valve or other device against loss of air or vacuum if the supply fails or leaks.
- (5) However, subrule (4) (a) does not apply to a vehicle with a GVM of 4.5 tonnes or less that is fitted with an air or vacuum assisted braking system.
- (6) If air or vacuum brakes are fitted to a motor vehicle equipped to tow a trailer, the brakes of the vehicle must be able to stop the vehicle, at the performance standards for emergency brakes under rule 128 if the trailer breaks away.
- (7) The braking system of a motor vehicle with a GVM over 4.5 tonnes equipped to tow a trailer fitted with air brakes must include protection against loss of supply line air or brake control signal air.
- (8) The protection mentioned in subrule (7) must:
 - (a) operate automatically if a brake supply line hose connecting the motor vehicle and a trailer fails; and
 - (b) maintain enough air pressure to allow the brakes to be applied to meet performance standards for emergency brakes under rule 128; and
 - (c) include a visible or audible warning to the driver.

Division 3 Trailer braking systems

132 What brakes a trailer must have

- (1) A trailer with a GTM over 750 kilograms must have brakes that operate on at least 1 wheel at each end of 1 or more axles of the trailer.
- (2) A semi-trailer or converter dolly with a GTM over 2 tonnes must have brakes that operate on all its wheels.

133 Operation of brakes on trailers

- (1) The braking system of a trailer with a GTM over 2 tonnes must allow the driver of a motor vehicle towing the trailer to operate the brakes from a normal driving position.
- (2) However, subrule (1) does not apply to an unloaded converter dolly that weighs under 3 tonnes if the motor vehicle towing the converter dolly has a GVM over 12 tonnes.
- (3) The brakes on a trailer with a GTM over 2 tonnes must:
 - (a) operate automatically and quickly if the trailer breaks away from the towing vehicle; and
 - (b) remain in operation for at least 15 minutes after a break-away; and
 - (c) be able to hold the trailer on a 12% grade while in operation after a break-away.

134 Air or vacuum brakes on trailers

- (1) If a trailer has air brakes, its braking system must include at least 1 air storage tank.
- (2) If a trailer has vacuum brakes, its braking system must include at least 1 vacuum storage tank.

- (3) An air or vacuum storage system must:
 - (a) be built to give a visible or audible warning to the driver of the towing vehicle, while in a normal driving position, of a lack of air or vacuum that would prevent the brakes from meeting the performance standards of rule 128; and
 - (b) be safeguarded by a check valve or other device against loss of air or vacuum if the supply fails or leaks.
- (4) Subrules (1), (2) and (3) do not apply to a trailer with a GTM of 2 tonnes or less.

Division 4 Additional brake requirements for B-doubles and long road trains

135 Application of Division to certain road trains

This Division does not apply to a road train, or a vehicle used in a road train, if the road train has a length of 19 metres or less.

136 Braking system design for a prime mover in a B-double

- (1) A prime mover used in a B-double must comply with second edition ADR 35A or third edition ADR 35.
- (2) A prime mover used in a B-double must also have an anti-lock braking system complying with third edition ADR 64, if the prime mover:
 - (a) was built after 1989; or
 - (b) was first used in a B-double after 1993; or
 - (c) is used in a B-double that includes a road tank vehicle carrying dangerous goods.

137 Braking system design for motor vehicles in road trains

The performance of the service, secondary and parking brake systems of a motor vehicle used in a road train must comply with second edition ADR 35A or third edition ADR 35 if the vehicle would not otherwise be required to comply with an ADR about braking.

138 Braking system design for trailers in B-doubles or road trains

- (1) The performance of the service, secondary and parking brake systems of a trailer used in a B-double or road train must comply with second edition ADR 38 or third edition ADR 38 if

the trailer would not otherwise be required to comply with an ADR about braking.

- (2) A road train trailer to which subrule (1) applies need not be fitted with a mechanical parking brake if it carries wheel chocks that provide a performance equal to the performance standard required for a parking brake system.
- (3) A semi-trailer, regardless of when it was built, must have an anti-lock braking system that complies with third edition ADR 38/01, if:
 - (a) it is being used in a B-double that includes a road tank vehicle, whether or not the semi-trailer is itself a road tank vehicle; and
 - (b) the road tank vehicle is carrying dangerous goods.

139 Air brakes of motor vehicles in B-doubles or road trains

- (1) If a B-double or road train is fitted with brakes that operate using compressed air, the braking system of the motor vehicle must comply with subrules (2) and (3) when:
 - (a) the pressure is measured in an 800 millilitre vessel connected by a 2 metre pipe with a bore of approximately 13 millimetres to the coupling head of the braking system; and
 - (b) the air pressure before the brakes are applied is not under:
 - (i) the average of the maximum and minimum pressures in the operating pressure range specified by the vehicle's manufacturer; or
 - (ii) if there is no manufacturer's specification — 650 kilopascals.
- (2) The pressure must reach at least 420 kilopascals within 400 milliseconds after the rapid and complete application of the foot-operated brake control.
- (3) After the brakes have been fully applied, the pressure must fall, within half a second after the release of the foot-operated brake control, to 35 kilopascals.

140 Air brakes in a B-double or road train: least favoured chamber

- (1) In this rule:
least favoured chamber means the brake chamber with the longest line to the treadle valve in the prime mover.
- (2) The pressure in the least favoured chamber of the braking system of a B-double or road train with brakes that operate using compressed air must comply with subrules (3) and (4) when the air pressure before the brakes are applied is not under:
 - (a) the average of the maximum and minimum pressures in the operating pressure range specified by the vehicle's manufacturer; or
 - (b) if there is no manufacturer's specification — 650 kilopascals.
- (3) The pressure must reach at least 420 kilopascals within:
 - (a) for a B-double — 1 second after the rapid and complete application of the foot-operated brake control; or
 - (b) for a road train — 1.5 seconds after the rapid and complete application of the foot-operated brake control.
- (4) After the brakes have been fully applied, the pressure must fall to 35 kilopascals, or the pressure at which the friction surfaces cease to contact each other, within:
 - (a) for a B-double — 1 second after the release of the foot-operated brake control; or
 - (b) for a road train — 1.5 seconds after the release of the foot-operated brake control.

141 Recovery of air pressure for brakes in B-doubles and road trains

The air pressure in each air brake reservoir in a B-double or road train must recover to at least 420 kilopascals within 1 minute after 3 full brake applications have been made within a 10 second period if, before the 3 brake applications have been made:

- (a) the engine is running at maximum speed; and
- (b) the governor cut-in pressure is no higher than:
 - (i) the pressure specified by the vehicle's manufacturer; or
 - (ii) if there is no manufacturer's specification — 550 kilopascals; and
- (c) the air pressure in the storage tanks of the vehicle is not under:
 - (i) the average of the maximum and minimum pressures in the operating pressure range specified by the vehicle's manufacturer; or
 - (ii) if there is no manufacturer's specification — 650 kilopascals.

142 Air supply for brakes in B-doubles and road trains

A B-double or road train that uses compressed air to operate accessories must have:

- (a) sufficient air compressor capacity and air receiver volume to ensure that the operation of the accessories does not adversely affect brake performance; and
- (b) a compressed air system built to ensure that the brake system is preferentially charged.

143 Brake line couplings

- (1) Brake line couplings on the same part of a vehicle in a B-double or road train must not be interchangeable.
- (2) The couplings must be polarised in accordance with Australian Standard AS D8-1971 *Hose Couplings for Use with Vacuum and Air-Pressure Braking Systems on Prime Movers, Trailers and Semi-trailers* if the hoses used with the brake couplings are used for the same purpose as the hoses mentioned in the standard.

144 Simultaneous parking brake application

- (1) If the parking brake of a motor vehicle in a B-double or road train is applied, the parking brakes of any attached trailer must be applied automatically.
- (2) This rule does not apply to a trailer carrying wheel chocks complying with rule 138 (2).

145 Capacity of air reservoirs

- (1) The capacity of the air storage tanks of a motor vehicle used in a B-double or road train must be at least 12 times the volume of all the brake activation chambers on the motor vehicle.
- (2) The capacity of the air storage tanks of a trailer used in a B-double or road train must be at least 8 times the volume of all the brake activation chambers on the trailer.

Part 10 Control of emissions

Note This Part sets out requirements to ensure that motor vehicles do not emit too much smoke or noise and that exhaust gases cannot enter the passenger compartment of a vehicle.

Division 1 Crank case gases and exhaust emissions

Division 1
heading amended
by Item 1

146 Crank case gases – certain petrol-powered vehicles

Rule 146 heading
amended by Item
1

- (1) This rule applies to a motor vehicle with 4 or more wheels that is powered by a petrol engine and was built after 1971.
- (2) The vehicle must be built to prevent, or fitted with equipment that prevents, crank case gases from escaping to the atmosphere.

147 Visible exhaust emissions – vehicles with internal combustion engines

Rule 147 heading
amended by Item
1

- (1) This rule applies to a motor vehicle that is propelled by an internal combustion engine and was built after 1930.
- (2) The vehicle must not emit visible emissions for a continuous period of at least 10 seconds.
- (3) However, this rule does not apply to emissions that are visible only because of heat or the condensation of water vapour.

147A Exhaust emissions — diesel-powered vehicles

Rule 147A
inserted by Item 1

- (1) This rule applies to registered passenger vehicles, omnibuses and goods vehicles:
 - (a) powered by diesel engines; and
 - (b) meeting the criteria for an M-category or N-category vehicle under the Australian Design Rules.
- (2) In this rule:

vehicle test mass for a vehicle means:

- (a) if the vehicle is a prime mover — half the sum of its tare mass and its GCM; or
- (b) in any other case — half the sum of its tare mass and its GVM.

Note The **vehicle test mass** is the load applied to the dynamometer, while the vehicle is under test, to simulate half payload operation.

- (3) For subrule (4), a vehicle is taken to have been manufactured in the month shown on its compliance plate (that is, the plate, of the kind referred to in section 10A of the *Motor Vehicle Standards Act 1989*, affixed or taken to be affixed to the vehicle) as its month of manufacture.
- (4) When a vehicle is tested in accordance with the procedure described in Schedule 1 by means of test equipment that complies with the specification mentioned in subrule (5):
 - (a) the vehicle must not emit oxides of nitrogen (NO_x) at a rate (measured in grams of NO_x emitted per kilometre travelled per tonne of the vehicle's test mass) greater than that specified for the vehicle according to its GVM rating and age in the following table:

Vehicle's GVM rating (t)	Rate of NO _x emissions (g/km/t)	
	Vehicle manufactured in December 1995 or earlier	Vehicle manufactured in January 1996 or later
Not greater than 3.5	1.5	1.5
More than 3.5 but not greater than 12	2.0	2.0
More than 12 but not greater than 25	2.0	1.5
More than 25	1.5	1.5

and

- (b) the vehicle must not emit particles at a rate (measured in grams of particles emitted per kilometre travelled per tonne of the vehicle's test mass) greater than that specified for the vehicle according to its GVM rating and age in the following table:

Vehicle's GVM rating (t)	Rate of particle emissions (g/km/t)	
	Vehicle manufactured in December 1995 or earlier	Vehicle manufactured in January 1996 or later
Not greater than 3.5	0.23	0.23
More than 3.5 but not greater than 12	0.23	0.15
More than 12 but not greater than 25	0.08	0.08
More than 25	0.07	0.03;

and

- (c) the opacity of the exhaust gas emitted by the vehicle must not be greater than 25% (averaged over a DT 80 test cycle in the way described or referred to in the specification).
- (5) The specification for subrule (4) is that set out in the document known as *Technical and functional specification for a diesel vehicle emissions measuring system*, published by the National Road Transport Commission from time to time (as far as that specification requires particular values of measurement capability, accuracy and stability).

Division 2 Exhaust systems

148 Exhaust systems

- (1) The outlet of the exhaust system fitted to a motor vehicle (except a bus) must extend:
 - (a) behind the back seat; and
 - (b) at least 40 millimetres beyond the outermost joint of the floorpan that is not continuously welded or permanently sealed; and
 - (c) to the edge of the vehicle, if:
 - (i) the body of the vehicle is permanently enclosed; and
 - (ii) the vehicle is not fitted with a vertical exhaust system; and
 - (d) no further than the edge of the vehicle at its widest point.
- (2) The outlet must discharge the main exhaust flow to the air:
 - (a) if the vehicle is fitted, or required under a law of this jurisdiction to be fitted, with an exhaust system with a vertical outlet pipe:
 - (i) at an angle above the horizontal; and
 - (ii) at least 150 millimetres above the cab of the vehicle; and
 - (iii) rearwards or to the right of the vehicle; and
 - (b) in any other case:
 - (i) horizontally or at an angle of not over 45° downwards; and
 - (ii) under 750 millimetres above ground level; and
 - (iii) rearwards or to the right of the vehicle.
- (3) An exposed section of a vertical exhaust system fitted to a motor vehicle (except a bus) with a GVM over 4.5 tonnes must be positioned or shielded to prevent injury.

Rule 148(1) amended by Item 4

- (4) The outlet of the exhaust system fitted to a bus with a GVM over 4.5 tonnes must:
 - (a) be as near as practicable to the rear of the vehicle; and
 - (b) extend no further than the edge of the bus at its widest point.
- (5) The outlet must discharge the main exhaust flow to the air:
 - (a) if the bus is fitted, or required under a law of this jurisdiction to be fitted, with an exhaust system with a vertical outlet pipe:
 - (i) behind the passenger compartment; and
 - (ii) at an angle above the horizontal; and
 - (iii) upwards or rearwards; and
 - (b) in any other case:
 - (i) horizontally or at an angle of not over 45° downwards; and
 - (ii) rearwards or to the right of the vehicle.
- (6) A vertical exhaust system fitted to a motor vehicle with a GVM over 4.5 tonnes must:
 - (a) if the vehicle is fitted with an exhaust system with a vertical outlet pipe that does not direct the main exhaust flow straight up — direct the flow rearwards at an angle within 0° to 45° of the longitudinal centre line of the vehicle; and
 - (b) if a rain cap is fitted to the outlet pipe — be installed so the hinge of the cap is at an angle of 90° (plus or minus 10°) to the longitudinal centre line of the vehicle when viewed from above.

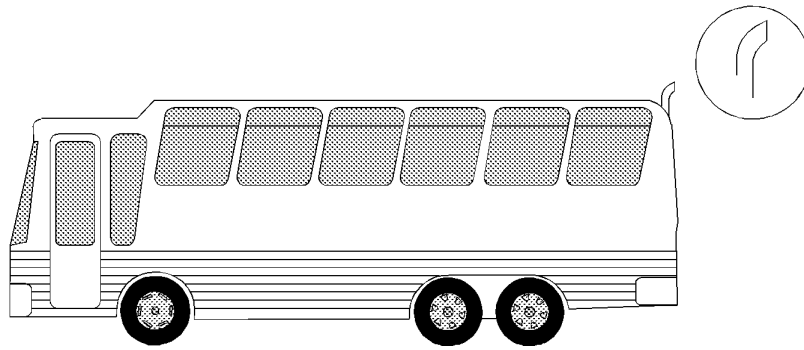

Bus exhaust outlet pipe

Division 3 Noise emissions

Subdivision A General

148A Measurement of stationary noise levels

Rule 148A
inserted by Item 2

- (1) For this Division, the stationary noise level of a motor vehicle is to be measured in accordance with the procedure set out for the kind of vehicle in the document entitled 'National Stationary Exhaust Noise Test Procedures for In-Service Motor Vehicles' published by the Commission in April 2000.
- (2) In subregulation (1), *Commission* means the National Road Transport Commission established by the *National Road Transport Commission Act 1991* of the Commonwealth.

Note 'National Stationary Exhaust Noise Test Procedures for In-Service Motor Vehicles' is available on the Commission's website at www.nrtc.gov.au/publications/report-42.asp

148B Meaning of *certified to ADR83/00*

Rule 148B
inserted by Item 2

For this Division, a vehicle is certified to ADR 83/00 if approval has been given, under section 10A of the *Motor Vehicle Standards Act 1989* of the Commonwealth, to place identification plates showing compliance with ADR 83/00 on vehicles of that type.

149 Silencing device for exhaust systems

A motor vehicle propelled by an internal combustion engine must be fitted with a silencing device through which all the exhaust from the engine passes.

Subdivision B Noise levels applying to pre-2004 vehicles

149A Application of rules in subdivision B

Rule 149A
inserted by Item 2

This Subdivision applies to a motor vehicle other than a vehicle certified to ADR 83/00.

150 Stationary noise levels — car-type vehicles and motor bikes and trikes

- (1) In this rule:
car-type vehicle means:
 - (a) a car; or
 - (b) a utility truck, panel van, or another motor vehicle derived from a car design; or
 - (c) another motor vehicle with 4 or more wheels that is built mainly to carry not over 9 people including the driver.
- (2) The stationary noise level of a car-type vehicle, or motor bike or trike, must not exceed:
 - (a) for a car-type vehicle built after 1982 — 90 dB(A); or
 - (b) for another car-type vehicle — 96 dB(A); or
 - (c) for a motor bike or trike built after February 1985 — 94 dB(A); or
 - (d) for another motor bike or trike — 100 dB(A).
- (3) However, this rule does not apply to a car-type vehicle built after 1982 for 2 years after the commencement of this rule, if:
 - (a) the stationary noise level of the vehicle does not exceed 96 dB(A); and
 - (b) the stationary noise level limit applying to the vehicle under the law of the State or Territory where the vehicle is registered, or otherwise authorised to be driven on a road or road-related area, by a vehicle registration authority is not 90 dB(A) or less.

151 Stationary noise levels — other vehicles with spark ignition engines

- (1) This rule applies to a motor vehicle (except a motor vehicle to which rule 150 applies) with a spark ignition engine.
- (2) The stationary noise level of the motor vehicle must not exceed the noise level applying to the vehicle under the table.

Column 1 Item	Column 2 GVM (t)	Column 3 Exhaust height (mm)	Column 4 When vehicle built	Column 5 Noise level (dB(A))
1	≤ 3.5	<1500	before July 1983	92
			after June 1983	89
2	>3.5	<1500	before July 1983	98
			after June 1983	95
3	≤ 3.5	≥ 1500	before July 1983	88
			after June 1983	85
4	>3.5	≥ 1500	before July 1983	94
			after June 1983	91

152 Stationary noise levels — other vehicles with diesel engines

- (1) This rule applies to a motor vehicle (except a motor vehicle to which rule 150 applies) with a diesel engine.
- (2) The stationary noise level of the motor vehicle must not exceed the noise level applying to the vehicle under the table.

Column 1 Item	Column 2 GVM (t)	Column 3 Exhaust height (mm)	Column 4 When vehicle built	Column 5 Noise level (dB(A))
1	≤ 3.5	<1500	before July 1980	105
			after June 1980 but before July 1983	102
			after June 1983	99
2	>3.5 but ≤ 12	<1500	before July 1980	107
			after June 1980 but before July 1983	104
			after June 1983	101
3	>12	<1500	before July 1980	109
			after June 1980 but before July 1983	106
			after June 1983	103
4	≤ 3.5	≥ 1500	before July 1980	101
			after June 1980 but before July 1983	98
			after June 1983	95
5	>3.5 but ≤ 12	≥ 1500	before July 1980	103
			after June 1980 but before July 1983	100
			after June 1983	97
6	>12	≥ 1500	before July 1980	105

Column 1 Item	Column 2 GVM (t)	Column 3 Exhaust height (mm)	Column 4 When vehicle built	Column 5 Noise level (dB(A))
			after June 1980 but before July 1983	102
			after June 1983	99

Subdivision C Noise levels applying to vehicles certified to ADR 83/00

153 Stationary noise levels

The stationary noise level of a motor vehicle that is certified to ADR 83/00 must not exceed, by more than 5 dB(A), the noise level that is established for the motor vehicle when it is certified.

Rule 153
substituted by
Item 2

Part 11 LPG fuel systems

Note This Part sets out requirements to ensure that LPG fuel systems are safely installed in motor vehicles and that vehicles with LPG installed can be identified as LPG-powered vehicles.

154 LPG-powered vehicles

- (1) A motor vehicle equipped to run on LPG must comply with the requirements for the use of LPG in vehicles in:
 - (a) the version of Australian Standard AS 1425 in force at the commencement of this rule; or
 - (b) if an earlier version of the standard was current when the vehicle was first equipped to run on LPG — that version.
- (2) A vehicle equipped to run on LPG must have fixed conspicuously to the front and rear number plates a label that is:
 - (a) made of durable material; and
 - (b) at least 25 millimetres wide and 25 millimetres high; and
 - (c) reflective red conforming to Australian Standard AS 1742-1975 *Manual of Uniform Traffic Control Devices*, Appendix C, Class 2; and
 - (d) marked 'LPGAS' or 'LPG', or with words or acronyms to similar effect, in capital letters at least 6 millimetres high.



Part 12 Maximum road speed limiting

Note This Part requires certain heavy vehicles built after 1987, but before July 1991, to have a restricted top speed. However, emergency vehicles and certain 2-axle prime movers owned by farmers and used in primary production are exempt.

155 Speed limiting

- (1) A bus with a GVM over 14.5 tonnes that was built after 1987 must comply with third edition ADR 65.
- (2) A prime mover with a GVM over 15 tonnes that was built after 1987 must comply with third edition ADR 65.
- (3) For third edition ADR 65, the maximum road speed capability of a motor vehicle used in a road train is 90 kilometres an hour.

Note Vehicle Standards Bulletin 2 (VSB 2) contains the requirements of third edition ADR 65. The Bulletin is available from the Department of Transport and Regional Services.

Rule 155(3) Note, amended by Item 4

156 Exemptions from speed limiting

Rule 155 does not apply to:

- (a) an emergency vehicle or police vehicle; or
- (b) a bus fitted with hand grips or similar equipment for standing passengers to hold; or
- (c) a 2-axle prime mover if:
 - (i) it was built after 1987 but before July 1991; and
 - (ii) its owner is a person who uses it for agriculture, horticulture, or other primary production activities (except forestry, fishing and mining).

Part 13 Mechanical connections between vehicles

Note This Part sets out various requirements to ensure that the couplings used when operating motor vehicles and trailers in combinations are strong enough to hold them together.

The requirements in this Part about the mechanical connections between vehicles in a road train do not apply to a road train 19 metres long or less.

Division 1 Couplings on all types of vehicles

157 General coupling requirements

- (1) A fifth wheel coupling, the mating parts of a coupling, a kingpin or a towbar must not be used for a load more than the manufacturer's load rating.
- (2) A kingpin must be used only with a fifth wheel coupling that has a corresponding jaw size.

Example

An adaptor must not be used to fit a kingpin to a fifth wheel coupling.

- (3) The mating parts of a coupling used to connect a semi-trailer to a towing vehicle must not allow the semi-trailer to roll to an extent that makes the towing vehicle unstable.

158 Drawbar couplings

- (1) A coupling for attaching a trailer, except a semi-trailer or pole-type trailer, to a towing vehicle must be built and fitted so:
 - (a) the coupling is equipped with a positive locking mechanism; and
 - (b) the positive locking mechanism can be released regardless of the angle of the trailer to the towing vehicle.
- (2) If the trailer is in a combination and is not fitted with breakaway brakes in accordance with rule 133 (3), it must be connected to the towing vehicle by at least 1 chain, cable or

other flexible device, as well as the coupling required by subrule (1).

- (3) The connection must be built and fitted so:
 - (a) the trailer is kept in tow if the coupling breaks or accidentally detaches; and
 - (b) normal angular movement of the coupling is permitted without unnecessary slack.
- (4) If practicable, the connection must be built and fitted so the drawbar of the trailer is prevented from hitting the ground if the coupling accidentally detaches.

Division 2 Additional coupling requirements for B-doubles and long road trains

159 Application of Division to road trains

This Division does not apply to a vehicle, coupling, or part of a coupling, used in a road train not over 19 metres long.

160 Couplings for B-doubles and road trains

- (1) A fifth wheel coupling used to connect a towing vehicle to a semi-trailer used in a B-double or road train must not be built with a pivot that allows a semi-trailer to roll relative to the towing vehicle.
- (2) However, subrule (1) does not apply to a fifth wheel coupling if:
 - (a) the semi-trailer design requires torsional stresses to be minimised; and
 - (b) the roll axis of the fifth wheel coupling is above the surface of the coupler plate; and
 - (c) the degree of rotation allowed around the roll axis of the fifth wheel coupling is restricted to prevent roll instability.
- (3) A trailer with only 1 axle group, or a single axle, (except a semi-trailer or a converter dolly) that is used in a road train must not have a coupling fitted at its rear.

161 Selection of fifth wheel couplings for B-doubles and road trains

- (1) A fifth wheel coupling used in a B-double or road train must have a D-value complying with Australian Standard AS 1773-1990 *Articulated Vehicles—Fifth Wheel Assemblies*.
- (2) A turntable used in a B-double or road train must have a D-value complying with Australian Standard AS 1773-1990 *Articulated Vehicles—Fifth Wheel Assemblies*.

- (3) If a fifth wheel coupling used in a B-double or road train is built for a 50 millimetre or 90 millimetre kingpin, the coupling must:
 - (a) meet the dimension requirements in Australian Standard AS 1773-1990 *Articulated Vehicles-Fifth Wheel Assemblies*; and
 - (b) not be worn away more than recommended by the standard.
- (4) If a fifth wheel coupling used in a B-double or road train is built for a 75 millimetre kingpin, the coupling must:
 - (a) be compatible with the kingpin mentioned in rule 165 (3); and
 - (b) not be worn away so that it does not comply with rule 162.

162 D-value of a fifth wheel coupling

In testing a fifth wheel coupling built for a 75 millimetre kingpin used in a B-double or road train to decide whether its D-value complies with rule 161 (1), the longitudinal movement (after readjusting the jaws of the coupling using a kingpin built to the dimensions mentioned in rule 165 (3) (a)) must not be over 4 millimetres.

163 Mounting of fifth wheel couplings on B-doubles and road trains

A fifth wheel coupling must be mounted on a prime mover, or a semi-trailer used in a B-double or road train, in accordance with Australian Standard AS 1771-1987 *Installation of Fifth Wheel and Turntable Assemblies*.

164 Branding of fifth wheel couplings and turntables on B-doubles and road trains

- (1) A fifth wheel coupling on a vehicle built after June 1991 forming part of a B-double or road train must be clearly and permanently marked in accordance with Australian Standard

AS 1773-1990 *Articulated Vehicles–Fifth Wheel Assemblies*
with:

- (a) the name or trademark of its manufacturer; and
 - (b) its D-value rating; and
 - (c) its nominal size.
- (2) A turntable used in a vehicle built after the commencement of this rule that forms part of a B-double or road train must be marked with:
- (a) the name or trademark of the turntable’s manufacturer; and
 - (b) the D-value rating of the turntable in accordance with Australian Standard AS 1773-1990 *Articulated Vehicles–Fifth Wheel Assemblies*.

165 Selection of kingpins for B-doubles and road trains

- (1) A kingpin used in a B-double or road train must:
- (a) be a 50, 75 or 90 millimetre kingpin; and
 - (b) have a D-value complying with Australian Standard AS 2175-1990 *Articulated Vehicles–Kingpins*.
- (2) A 50 or 90 millimetre kingpin used in a B-double or road train must:
- (a) be built to meet the dimension requirements in Australian Standard AS 2175-1990 *Articulated Vehicles–Kingpins*; and
 - (b) not be worn away more than recommended by the standard.
- (3) A 75 millimetre kingpin used in a B-double or road train must:
- (a) be built to meet the dimensions in the following essential diagram; and
 - (b) not be worn away more than mentioned in subrule (4).

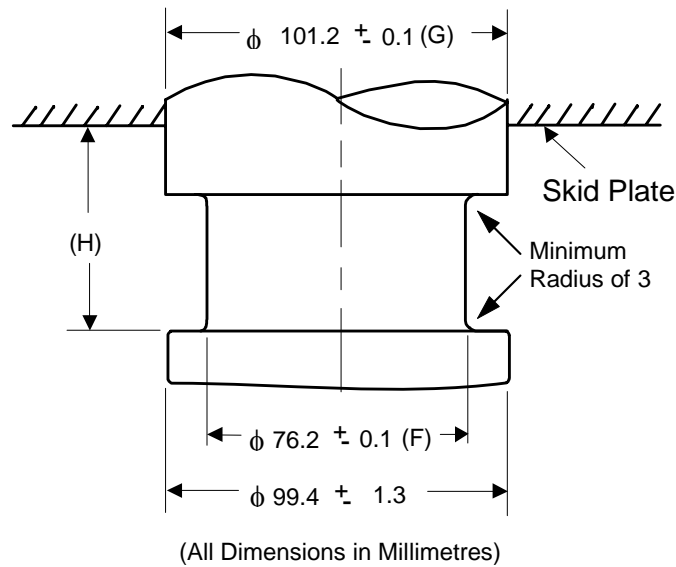

Dimensions of a 75 millimetre kingpin

- (4) In testing a 75 millimetre kingpin mentioned in the essential diagram in subrule (3) to decide whether its D-value complies with subrule (1) (b):
- diameter F must not wear more than 3 millimetres; and
 - diameter G must not wear more than 2 millimetres; and
 - height H must not wear more than 2.3 millimetres.

166 Attachment of kingpins on B-doubles and road trains

A kingpin used in a trailer that forms part of a B-double or road train must be attached in accordance with:

- the manufacturer's specifications and instructions; or
- the guidelines detailed in Australian Standard AS 2175-1990 *Articulated Vehicles—Kingpins*.

167 Branding of kingpins on B-doubles and road trains

A kingpin used in a trailer built after June 1991 that forms part of a B-double or road train must be clearly and permanently marked on the lower circular face of the kingpin in accordance with Australian Standard AS 2175-1990 *Articulated Vehicles—Kingpins* with:

- (a) the name or trademark of its manufacturer; and
- (b) its D-value rating; and
- (c) its nominal size.

168 Selection of couplings and drawbar eyes for road trains

A drawbar-type coupling, or drawbar eye, used in a road train must:

- (a) be a 50 millimetre pin type; and
- (b) have a D-value complying with Australian Standard AS 2213-1984 *50mm Pin Type Couplings and Drawbar Eyes for Trailers*; and
- (c) be built to the dimensions mentioned in the standard; and
- (d) not be worn away more than is recommended in the standard.

169 Attachment of couplings and drawbar eyes on road trains

- (1) A drawbar-type coupling, or drawbar eye, used in a road train must be built and positioned so:
 - (a) when the road train is moving, the drawbar can move at least 15° upwards or downwards from the position it occupies when the road train is parked on level ground; and
 - (b) the pivot point of the coupling is not over 300 millimetres forward of the rear of the trailer to which it is attached unless another rule of this jurisdiction allows a greater distance; and

Rule 169(1)
amended by Item
4

Rule 169(1)(b)
substituted by
Item 4

- (c) it is at a height of at least 800 millimetres, but not over 950 millimetres, when the road train is unloaded and parked on level ground.
- (2) The requirements of paragraph (1)(b) apply to a vehicle instead of the corresponding requirements in the relevant ADR.

Rule 169(2)
inserted by Item 4

170 Branding of couplings and drawbar eyes on road trains

A drawbar-type coupling, or drawbar eye, used on a vehicle built after June 1991 that forms part of a road train must be clearly and permanently marked in accordance with Australian Standard AS 2213-1984 *50mm-Pin Type Couplings and Drawbar Eyes for Trailers* with:

- (a) the name or trademark of its manufacturer; and
- (b) its D-value rating.

171 Tow coupling overhang on road trains

- (1) In this rule:
tow coupling overhang, of a vehicle, means the horizontal distance from the centre of the axle group, or the centre line of the single axle, at the rear of the vehicle to the pivot point of the coupling near the rear of the vehicle.
- (2) The tow coupling overhang of a motor vehicle, except a prime mover, used in a road train must not be more than the greater of:
 - (a) 30% of the distance from the centre of the front axle to the centre of the axle group or single axle at the rear of the vehicle; and
 - (b) 2.7 metres.
- (3) The tow coupling overhang of a semi-trailer, or a dog trailer consisting of a semi-trailer and converter dolly, used in a road train must not be more than 30% of the distance from the point of articulation to the centre of the axle group or single axle at the rear of the vehicle.

- (4) The tow coupling overhang of another dog trailer used in a road train must not be more than 30% of the distance from the centre of the front axle group or single axle to the centre of the axle group or single axle at the rear of the vehicle.

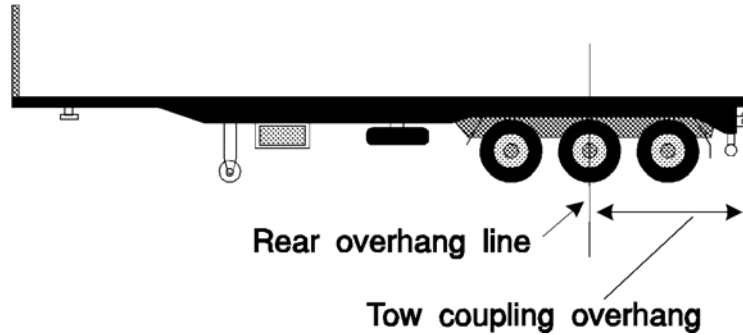

Tow coupling overhang — semi-trailer with extra coupling at rear

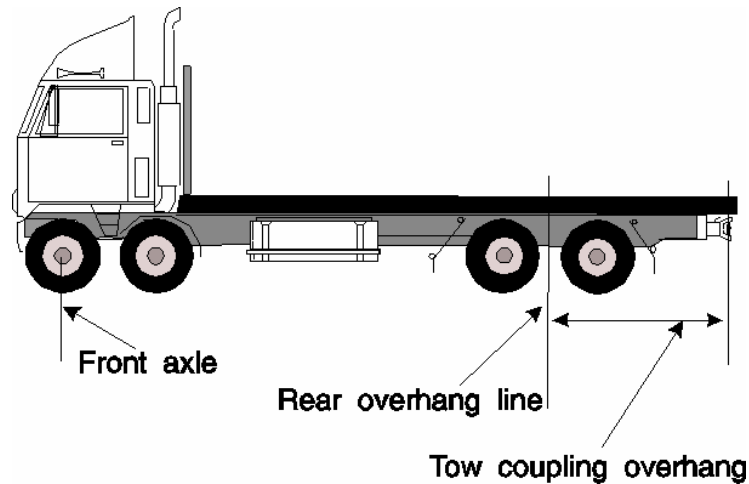

Tow coupling overhang — motor vehicle

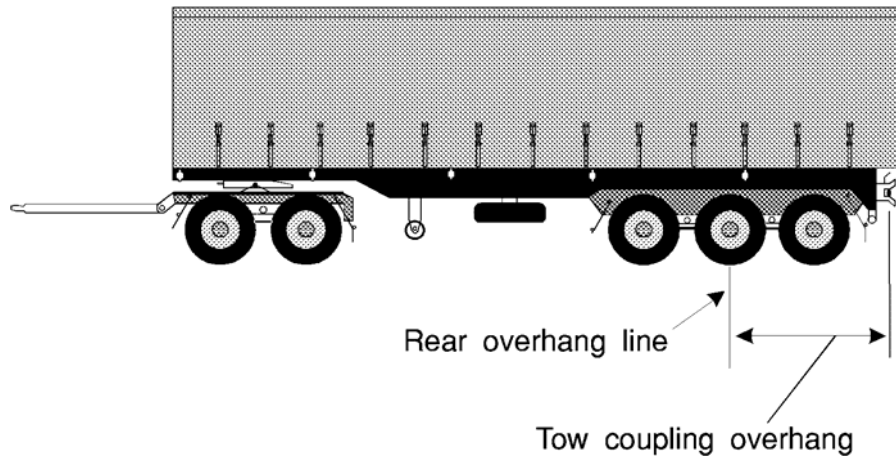

Tow coupling overhang — dog trailer

Part 14 Other matters

172 Vehicle equipment

A vehicle is taken to have equipment mentioned in the Vehicle Standards only if the equipment is in working order.

173 Restored vehicles

- (1) For the Vehicle Standards, a restored vehicle is taken to have been built when it was originally built and not when it was restored.
- (2) In this rule:
restored vehicle means a vehicle that is being, or has been, restored to its manufacturer's specifications, so far as it is practicable to meet the specifications.

174 Retractable axles

- (1) For the Vehicle Standards, a retractable axle is taken to be an axle only when it is in the lowered position.
- (2) In this rule:
retractable axle means an axle with a means of adjustment enabling it to be raised or lowered relative to the other axles in the axle group.

175 Measurement of distance between parallel lines

For the Vehicle Standards, a distance between 2 parallel lines is measured at right angles between the lines.

176 Interpretation of certain second edition ADRs

The words 'left' and 'right' in the following second edition ADRs have the opposite meaning in the application of the

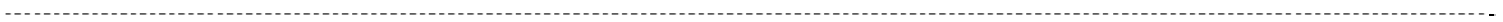

ADRs, in accordance with the Vehicle Standards, to a motor vehicle with a left-hand drive:

- ADR 8 Safety Glass
- ADR 12 Glare Reduction in Field of View
- ADR 14 Rear Vision Mirrors
- ADR 16 Windscreen Wipers and Washers
- ADRs 18 and 18A Location and Visibility of Instruments
- ADRs 35 and 35A Commercial Vehicle Braking Systems.

Note The following table contains a list of some terms used in the third edition ADRs and the corresponding term used in the Vehicle Standards.

Third edition ADRs	Vehicle Standards
dipped-beam headlamp	low-beam (for a headlight)
front fog lamp	front fog light
rear fog lamp	rear fog light
wheelguard	mudguard
main-beam headlamp	high-beam (for a headlight)
reversing lamp	reversing light
direction indicator lamp	direction indicator light
stop lamp	brake light
rear registration plate lamp	number plate light
front position (side) lamp	parking light
rear position (side) lamp	tail light
end-outline marker lamp	front or rear clearance light
external cabin lamp	external cabin light
internal lamp	interior light

Third edition ADRs	Vehicle Standards
side marker lamp	side marker light
daytime running lamp	daytime running light
rear reflex reflector, non-triangular	rear reflector
front reflex reflector, non-triangular	front reflector
side reflex reflector, non-triangular	side reflector

Schedule 1

**DT80 transient test
procedure for testing of
diesel-fuelled vehicle
exhaust emissions**

Schedule 1
inserted by Item 1

(rule 147A)

- 1 Secure the vehicle on the dynamometer.
- 2 Set the dynamometer to simulate the correct load and inertia for the vehicle.
- 3 Start sampling.
- 4 Idle for 60 seconds.
- 5 Accelerate rapidly to 80 km/hr under simulated inertia, using wide open throttle, making gear changes as required for smooth acceleration.
- 6 Decelerate by removing all pressure from the accelerator pedal, disengaging the gears and gently applying brakes to bring the vehicle to a standstill.
- 7 Idle for 10 seconds.
- 8 Accelerate rapidly to 80 km/hr under simulated inertia, using wide open throttle, making gear changes as required for smooth acceleration.
- 9 Decelerate by removing all pressure from the accelerator pedal, disengaging the gears and gently applying brakes to bring the vehicle to a standstill.
- 10 Idle for 10 seconds.
- 11 Accelerate rapidly to 80 km/hr under simulated inertia, using wide open throttle, making gear changes as required for smooth acceleration.
- 12 Maintain speed at 80 km/hr for 60 seconds, then stop sampling. Bring the vehicle to rest.

Note Explanation of the test procedure

This test has been designed to evaluate vehicle emissions during typical 'real-world' operating modes and conditions. There are 3 simple modes:

- 3 idle periods
- acceleration to 80 km/h 3 times
- maintain speed at 80 km/h.

The graph below indicates the modes of operation. The actual test will result in a graph that has more variation than the indicative graph below, because of the need to change gears when accelerating. Modes B – D and E – G and H – I have no specific time interval. All the specified time periods have an error margin of ± 1 second.

The vehicle is accelerated rapidly to 80 km/h 3 times by applying wide-open throttle.

The driver selects the most appropriate gear change points for the vehicle being tested to achieve the correct speed.

The vehicle test mass for road load and inertia settings must be equal to the mass of the vehicle when operating with $\frac{1}{2}$ its nominal payload (that is, $GVM + \text{tare mass} \div 2$).

The vehicle's rolling resistance (based on tyre and bearing losses, frontal area and drag coefficient) must also be calculated and continuously factored into the dynamometer tractive effort calculations to ensure correct loading.

Empirical algorithms, based on vehicle test mass, GVM or other known parameters, may be used to automatically calculate realistic coefficients for these variables.

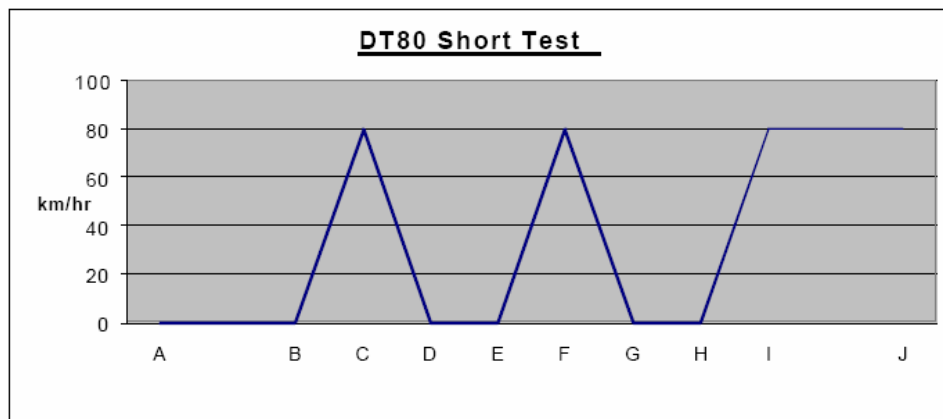

A simplified indicative graph produced by a test follows.

Dictionary

50 millimetre kingpin means a kingpin meeting the dimension requirements for a 50 millimetre kingpin in Australian Standard AS 2175-1990 *Articulated Vehicles Kingpins*.

75 millimetre kingpin means a kingpin with the dimensions mentioned in rule 165 (3).

90 millimetre kingpin means a kingpin meeting the dimension requirements for a 90 millimetre kingpin in Australian Standard AS 2175-1990 *Articulated Vehicles Kingpins*.

adopted standard see rule 24.

ADR see rule 14.

air brake means an air-operated or air-assisted brake.

articulated bus means a bus with at least 2 rigid sections that allow passengers access between the sections and are connected to allow rotary movement between the sections.

Australian Standard means a standard approved for publication on behalf of the Council of the Standards Association of Australia.

Note Copies of Australian Standards are available from offices of the Standards Association of Australia.

axle means 1 or more shafts, positioned in a line across a vehicle, on which 1 or more wheels intended to support the vehicle turn.

axle group means a single, tandem, twinsteer, tri, or quad axle group.

B-double means a combination consisting of a prime mover towing 2 semi-trailers.

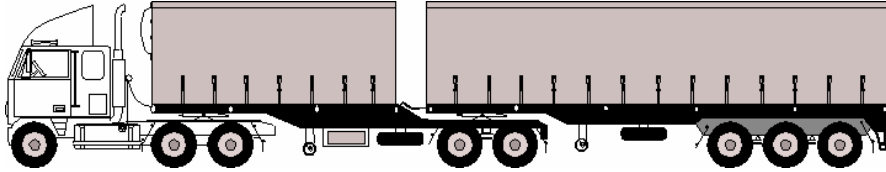

B-double

braking system, of a vehicle, means all the brakes of the vehicle and all the components of the mechanisms by which they are operated.

British Standard means a standard approved for publication on behalf of the British Standards Institution.

Note Copies of British Standards are available from offices of the Standards Association of Australia.

British Standards Institution means the institution of that name established under royal charter in the United Kingdom.

bus means a motor vehicle built mainly to carry people that seats over 9 adults (including the driver).

car means a motor vehicle built mainly to carry people that:

- (a) seats not over 9 adults (including the driver); and
- (b) has a body commonly known as a sedan, station wagon, coupe, convertible, or roadster; and
- (c) has 4 or more wheels.

centre line, of an axle group, means:

- (a) if the group consists of 2 axles, one of which is fitted with twice the number of tyres as the other axle — a line located one-third of the way from the centre line of the axle with more tyres towards the centre line of the axle with fewer tyres; and
- (b) in any other case — a line located midway between the centre lines of the outermost axles of the group.

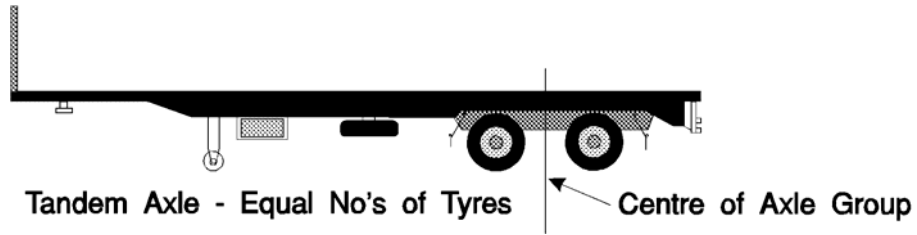

Centre line of a tandem axle group fitted with an equal number of tyres on each axle

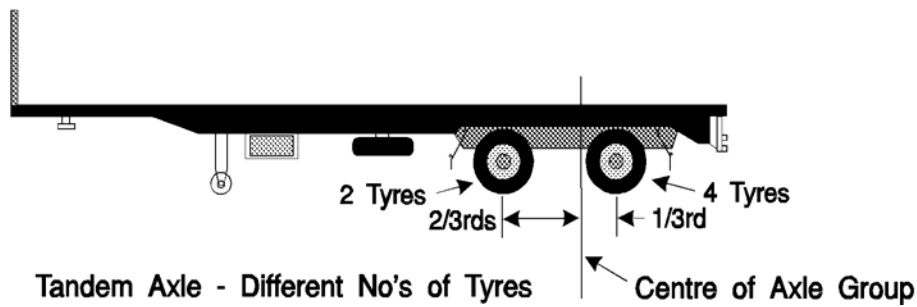

Centre line of a tandem axle group fitted with a different number of tyres on each axle

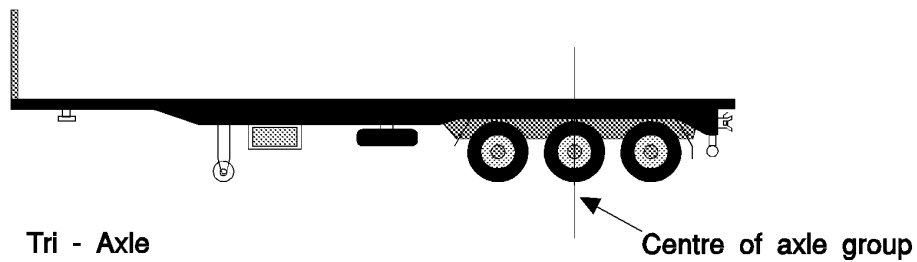

Centre line of a tri axle group

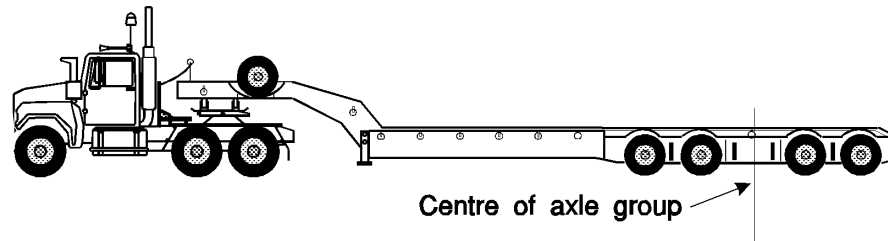

Centre line of a quad axle group

combination means a group of vehicles consisting of a motor vehicle connected to 1 or more vehicles.

controlled access bus means a bus, except an articulated bus, over 12.5 metres long.

converter dolly means a trailer with 1 axle group or single axle, and a fifth wheel coupling, designed to convert a semi-trailer into a dog trailer.

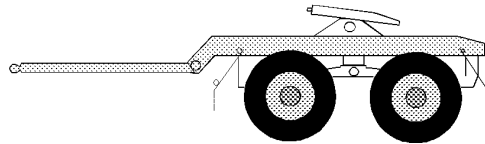

Converter dolly

daylight means the period in a day from sunrise to sunset.

dog trailer means a trailer (including a trailer consisting of a semi-trailer and converter dolly) with:

- (a) 1 axle group or single axle at the front that is steered by connection to the towing vehicle by a drawbar; and
- (b) 1 axle group or single axle at the rear.

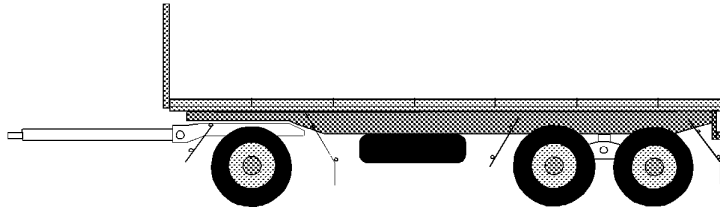

Dog trailer

drawbar means a part of a trailer (except a semi-trailer) connecting the trailer body to a coupling for towing purposes.

drive includes be in control of.

driver, of a vehicle, means the person driving the vehicle.

emergency brake means a brake designed to be used if a service brake fails.

emergency vehicle means a vehicle that is an emergency vehicle for the Vehicle Standards under a law of this jurisdiction.

fifth wheel coupling means a device, except the upper rotating element and the kingpin (which are parts of a semi-trailer), used with a prime mover, semi-trailer, or converter dolly, to allow quick coupling and uncoupling and to provide for articulation.

front fog light means a light used to improve the illumination of the road in case of fog, snowfall, heavy rain or a dust storm.

GCM or **gross combination mass** of a motor vehicle means the greatest possible sum of the maximum loaded mass of the motor vehicle and any vehicle or vehicles that may be towed by it at the same time:

- (a) as specified by the motor vehicle's manufacturer on an identification plate on the motor vehicle; or
- (b) if there is no such specification on an identification plate on the motor vehicle, or there is such a specification on a plate on the motor vehicle but the specification is not appropriate because the motor vehicle has been modified — as certified by the registration authority.

GCM inserted by
Item 1

GTM (gross trailer mass) means the mass transmitted to the ground by the axles of a trailer when the trailer is loaded to its GVM and connected to a towing vehicle.

GVM, for a vehicle, means the maximum loaded mass of the vehicle:

- (a) specified by the manufacturer on an identification plate on the vehicle; or
- (b) if there is no specification by the manufacturer on an identification plate on the vehicle or the specification is not appropriate because the vehicle has been modified — certified by the vehicle registration authority.

high-beam, for a headlight or front fog light fitted to a vehicle, means that the light is built or adjusted so, when the vehicle is standing on level ground, the top of the main beam of light projected is above the low-beam position.

left, for a vehicle, means to the left of the centre of the vehicle when viewed by a person in the vehicle who is facing to the front of the vehicle.

low-beam, for a headlight or front fog light fitted to a vehicle, means that the light is built or adjusted so, when the vehicle is standing on level ground, the top of the main beam of light projected is:

- (a) not higher than the centre of the headlight or fog light, when measured 8 metres in front of the vehicle; and
- (b) not over 1 metre higher than the level where the motor vehicle is standing, when measured 25 metres in front of the vehicle.

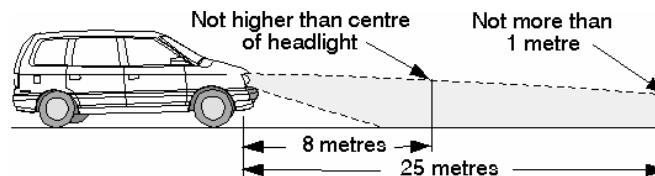

A headlight in the low-beam position

Ministerial Council means the Ministerial Council for Road Transport established by the Heavy Vehicles Agreement, a copy of which is set out

in Schedule 1 to the *National Road Transport Commission Act 1991* of the Commonwealth.

moped means a motor bike or trike with an engine cylinder capacity of not over 50 millilitres and a maximum speed of not over 50 kilometres an hour.

motor bike means a motor vehicle with 2 wheels, and includes a 2 wheeled motor vehicle with a sidecar attached to it that is supported by a third wheel.

motor trike means a motor vehicle with 3 wheels, but does not include a 2 wheeled motor vehicle with a sidecar attached to it that is supported by a third wheel.

motor vehicle means a vehicle built to be propelled by a motor that forms part of the vehicle.

mudguard means a fitting or device, with or without a mudflap, that is built and fitted to a vehicle in a way that will, as far as practicable, catch or deflect downwards any stone, mud, water, or other substance, thrown up by the rotation of the wheel to which the fitting or device is fitted.

national standard see rule 15.

point of articulation means:

- (a) the axis of a kingpin for a fifth wheel; or
- (b) the vertical axis of rotation of a fifth wheel coupling; or
- (c) the vertical axis of rotation of a turntable assembly; or
- (d) the vertical axis of rotation of the front axle group, or single axle, of a dog trailer; or
- (e) the coupling pivot point of a semi trailer.

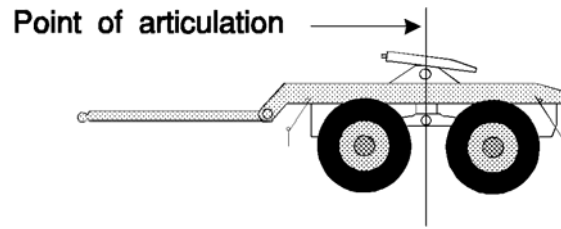

Point of articulation — fifth wheel coupling on a converter dolly (forming the front axle group of a dog trailer)

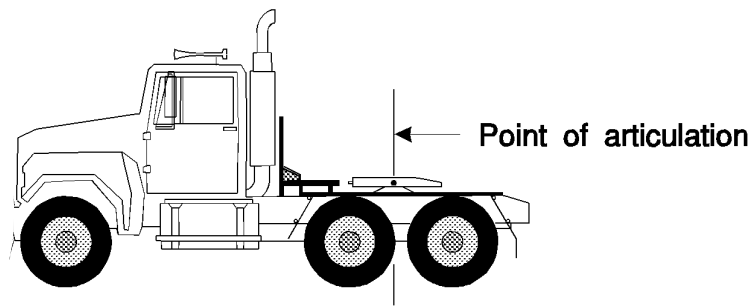

Point of articulation — fifth wheel on a prime mover

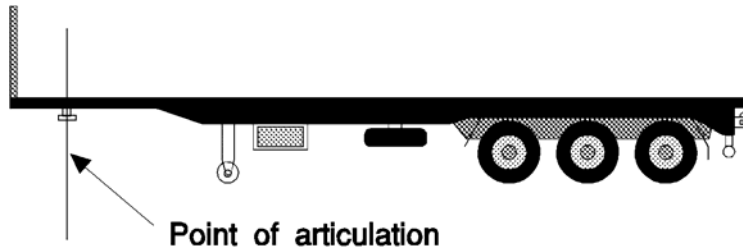

Point of articulation — kingpin for fifth wheel

pole-type trailer means a trailer that:

- (a) is attached to a towing vehicle by a pole, or an attachment fitted to the pole; and
- (b) is ordinarily used for transporting loads, such as logs, pipes, structural members, or other long objects, that can generally support themselves like beams between supports.

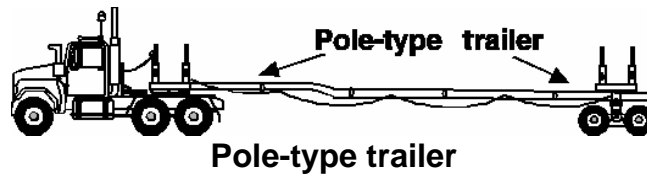

police vehicle means a vehicle driven by a police officer in the course of his or her duty.

prime mover means a motor vehicle built to tow a semi-trailer.

quad axle group means a group of 4 axles in which the horizontal distance between the centre lines of the outermost axles is over 3.2 metres, but not over 4.9 metres.

rear fog light means a light used on a vehicle to make it more easily visible from the rear in dense fog.

rear overhang, of a vehicle, means the distance between the rear overhang line and the rear of the vehicle.

rear overhang line, of a vehicle, means:

- (a) if there is a single axle at the rear of the vehicle — the centre line of the axle; or
- (b) if there is an axle group at the rear of the vehicle — the centre line of the axle group, decided without regard to the presence of any steerable axle unless all axles in the group are steerable.

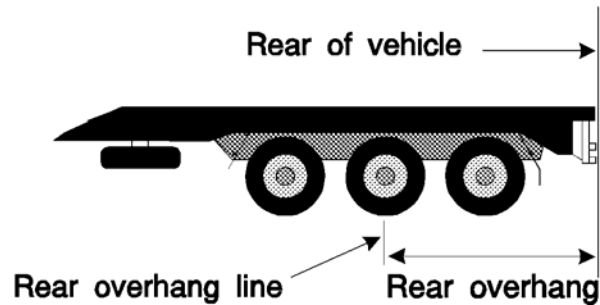

Rear overhang and rear overhang line — vehicle with tri axle group at rear

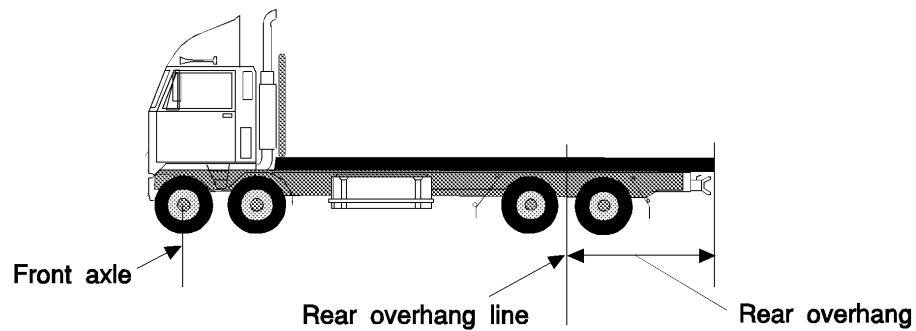

Rear overhang and rear overhang line — motor vehicle

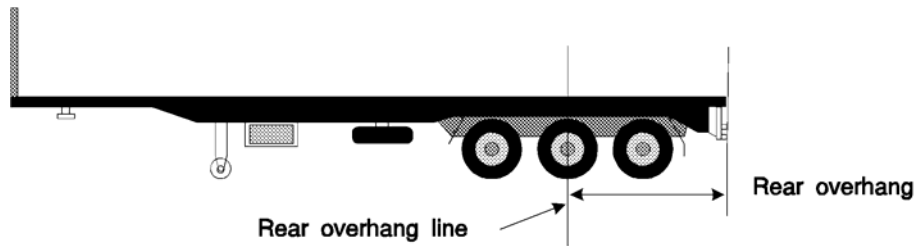

Rear overhang and rear overhang line — semi-trailer

repeater horn means a device that makes a sound alternating between different tones or frequencies on a regular time cycle.

right, for a vehicle, means to the right of the centre of the vehicle when viewed by a person in the vehicle who is facing to the front of the vehicle.

road see rule 8.

road-related area see rule 9.

road tank vehicle has the same meaning as in the sixth edition of the *Australian Code for the Transport of Dangerous Goods by Road and Rail*.

road train means a combination, except a B-double, consisting of a motor vehicle towing at least 2 trailers (counting as a single trailer a converter dolly supporting a semi-trailer).

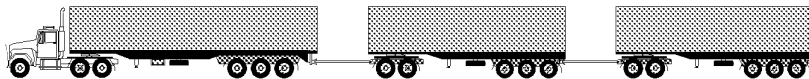

Road train

second edition ADR see rule 17.

semi-trailer means a trailer (including a pole-type trailer) that has:

- (a) 1 axle group or single axle to the rear; and
- (b) a means of attachment to a prime mover that results in some of the load being imposed on the prime mover.

service brake, for a vehicle, means the brake normally used to decelerate the vehicle.

single axle means an axle not forming part of an axle group.

single axle group means a group of at least 2 axles in which the horizontal distance between the centre lines of the outermost axles is under 1 metre.

spring brake means a brake using 1 or more springs to store the energy needed to operate the brake.

Standards Association of Australia means the association of that name incorporated in Australia under royal charter.

tandem axle group means a group of at least 2 axles in which the horizontal distance between the centre lines of the outermost axles is at least 1 metre, but not over 2 metres.

tare mass of a vehicle means its unladen mass (however described).

third edition ADR see rule 18.

transport enforcement vehicle means a vehicle that is a transport enforcement vehicle for the Vehicle Standards under a law of this jurisdiction.

trailer means a vehicle that is built to be towed, or is towed, by a motor vehicle, but does not include a motor vehicle that is being towed.

tri axle group means a group of at least 3 axles in which the horizontal distance between the centre lines of the outermost axles is over 2 metres, but not over 3.2 metres.

turntable means a bearing built to carry vertical and horizontal loads, but does not allow quick separation of its upper and lower rotating elements, and that is used to connect and allow articulation between:

- (a) a prime mover and semi-trailer; or
- (b) the steering axle or axle group of a dog trailer and the body of the trailer; or
- (c) a fifth wheel coupling and the vehicle to which it is mounted.

Tare mass inserted by Item 1

twinsteer axle group means a group of 2 axles:

- (a) with single tyres; and
- (b) fitted to a motor vehicle and connected to the same steering mechanism; and
- (c) the horizontal distance between the centre lines of which is at least 1 metre, but not over 2 metres.

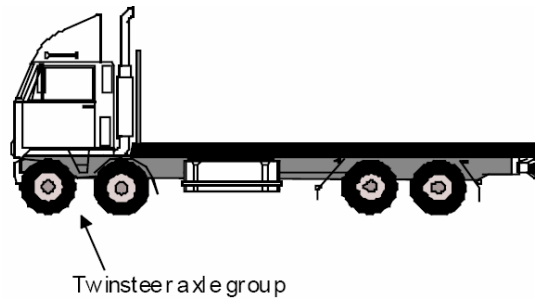

Twinsteer axle group on a motor vehicle

vacuum brakes means vacuum-operated or vacuum-assisted brakes.

vehicle includes the equipment fitted to, or forming part of, the vehicle.

VSB is the abbreviation for Vehicle Standards Bulletin.

Note The Vehicle Standard Bulletins provide information on the design, manufacture, sale, modification, maintenance, import and repair of road vehicles. The term "road vehicles" includes both motor vehicles and trailers. The Bulletins are available from the Department of Transport and Regional Services.

(See <http://www.dotars.gov.au/transreg/vsb/index.aspx>)

yellow includes amber.

Note

1. Made by the Governor-General on 1999, and notified in the *Commonwealth of Australia Gazette* on 1999.

VSB inserted by
Item 4

Amendments

This version of the Australian Vehicle Standards Rules includes the following amendments:

1. Road Transport Reform (Vehicle Standards) Amendment Regulations 2001 approved by the Australian Transport Council in August 2001.
2. Australian Vehicle Standards Amendment Rules 2002 approved by the Australian Transport Council on 10 January 2003.
3. National Transport Commission (Road Transport Legislation – Vehicle Standards) Amendment Regulations 2006 (No. 2). Approved by the Australian Transport Council 9 September 2005.
4. National Transport Commission (Road Transport Legislation – Vehicle Standards) Amendment Regulations 2007, approved by the Australian Transport Council in 23 August 2006

Editorial note

The National Transport Commission (Road Transport Legislation – Vehicle Standards) Amendment Regulations 2007 at Item 17 instructs to omit “A drawer-type coupling” and insert “(1) A drawer-type coupling”. Rule 169 refers to a “drawbar” not “drawer” this is a typographical error. For the purposes of this consolidation the word drawbar is retained. An amendment will be requested when future amendments are proposed.